

Sava

technical specification



.mdd

.mdd has a leading position among manufacturers of office furniture with many awards that prove quality and continuously increase demand for it's products.

The realities of today`s market require constant quality improvement at all levels of modern organization. This applies in particular to customer service, marketing, quality of products and also to quality of processes within the company.

Partnership relations among employees and with business partners form a base of economic growth and success of the company.

Constant investments in innovative machinery park, optimization of management systems and an expansion of production halls allow to minimize the lead times for the product of the highest quality.

More than twenty years of experience in office furniture industry come with reference from a long list of companies and institutions to show their appreciation for an efficient and comprehensive service.

.mdd is highly aware of the environment.

Being located in the forest region with lake by it's side, .mdd takes the nature seriously and invests constantly in a modern and energy-efficient solutions to preserve the local life. Company puts emphasis on waste segregation and recycling. .mdd has been awarded for the exceptional care and involvement in waste disposal. All materials used are environmentally friendly and enjoy a high 95 % rate of being recycled.



General informations:

Warranty:

.mdd products - **5 years.**

Electrical components and fabric - **2 years.**

Certificate - MFC:



Certificate - fabric:



Assembly:

product delivered in separate elements

Packing:

cardboard

Sava	Date of preparation 07.04.2021	The data contained in this document is valid in the day of its preparation. Change of the product, as long as it does not affect the basic features of it, does not require consistent updates of the document.	page 2/10 general informations
------	-----------------------------------	---	--

Technical specification

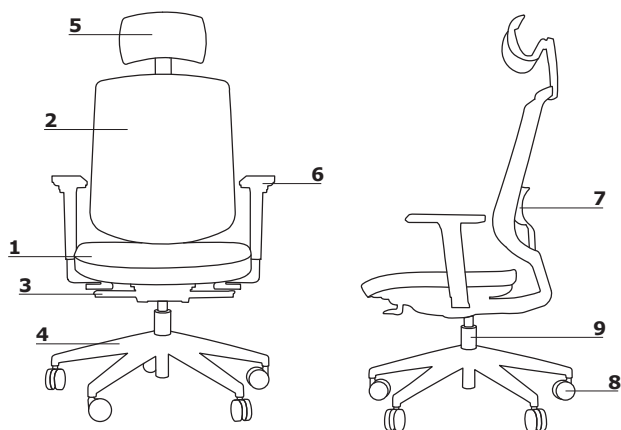

1. **Seat** - moulded foam, density of 66 kg/m³; upholstered, sliding
2. **Backrest** - mesh in Runner colours
3. **Mechanism** - Auto Synchro; OPTION WITH EXTRA CHARGE - Synchro Pro
4. **Base** - 5-star, polypropylene, Ø=680 mm, h=124 mm; OPTION WITH EXTRA CHARGE - 5-star, polished aluminium, Ø=680 mm, h=124 mm
5. **OPTION WITH EXTRA CHARGE** - headrest - black mesh
6. **OPTIONS WITH EXTRA CHARGE:**
 - armrest 2D - V3 - polyurethane, colour: black
 - armrest 3D - V3 - polyurethane, colour: black
7. **OPTION WITH EXTRA CHARGE** - manual height adjustable (60 mm) lumbar support
8. **Castors** - Ø65 mm, for soft floors PP+PA, colour: black; OPTION WITH EXTRA CHARGE - for hard floors PP+PA, colour: black
9. **Actuator** - steal gas spring; adjustment range 100 mm; colour: chrome or black

- max. load 120 kg

Mechanism

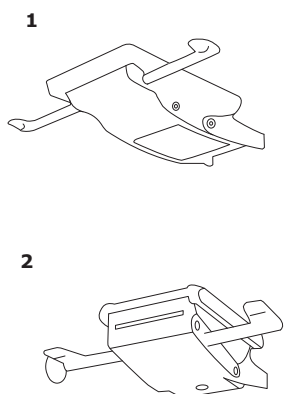

1. **AUTO SYNCHRO:**
 - synchronized automated regulation chair back press mechanism
 - designed for usage 45 and 120kg
 - allows the backrest to tilt from 0° to 18° and the seat to tilt from 0° to 4,5° at the same time
 - it is possible to lock the backrest only in the 0° position
 - seat depth adjustment range 100 mm, possibility to lock in 11 different positions
2. **SYNCHRO PRO:**
 - tilt angle of the backrest 25° and the seat 10°
 - designed for usage 45 and 120kg
 - additional seat and backrest tilt of 3°
 - 3 blocking positions of the backrest
 - Anti - shock system
 - adjustment of lateral tension
 - seat depth adjustment range 100 mm, possibility to lock in 11 different positions

Armrests

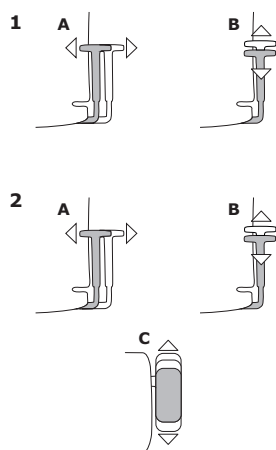

1. **Adjustable armrest - 2D-V3**
 - width adjustment (A)
 - height adjustment (B)
2. **Adjustable armrest - 3D-V3**
 - width adjustment (A)
 - height adjustment (B)
 - depth adjustment (width adjustment inwards) (C)

Dimensions

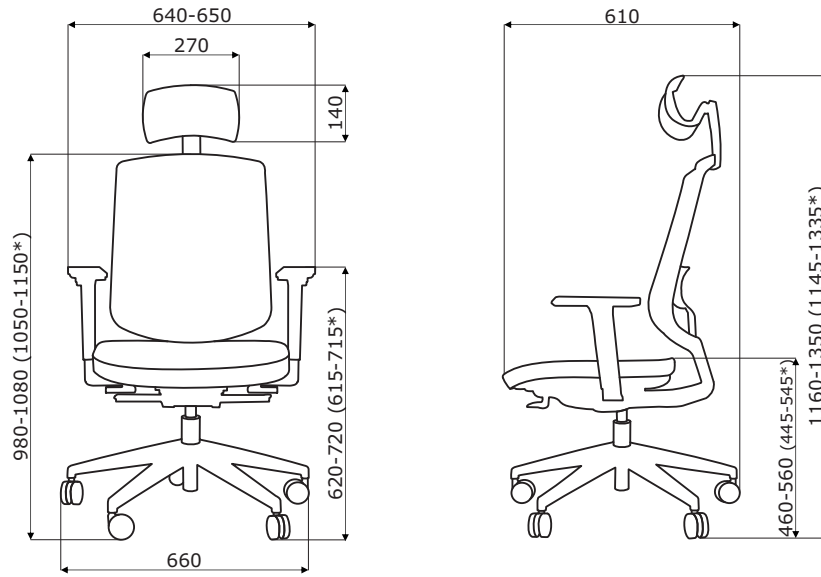

* Auto Synchro

Sava	Date of preparation 07.04.2021	The data contained in this document is valid in the day of its preparation. Change of the product, as long as it does not affect the basic features of it, does not require consistent updates of the document.	page 4/10
			dimensions (mm)

Sava *

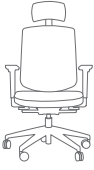

SAVA
660 / 610 / 1160-1350
20 kg

* dimensions expressed in millimeters: width x depth x height

Sava	Date of preparation 07.04.2021	The data contained in this document is valid in the day of its preparation. Change of the product, as long as it does not affect the basic features of it, does not require consistent updates of the document.	page 5/10
			products

Fabric Nemo

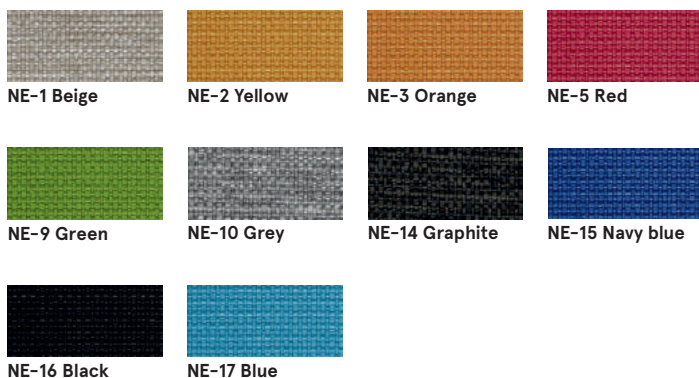

Technical data:

Material polyester 100%
Fabric weight 366g/m2
Abrasion resistance rubs PN_EN ISO 12947 - 2:2 100,000
Pilling resistance scale 1-8, max. 8, PN-EN ISO 105 - B02 (3-4)
Colour fastness to light scale 1-5, max. 5, PN-EN 1021 - 2,
Colour fastness to rubbing PN-EN 1021 - 1
 scale 1-5, max. 5, EN ISO 105x12 (wet/dry) 4-5

Fabric Runner - second price group

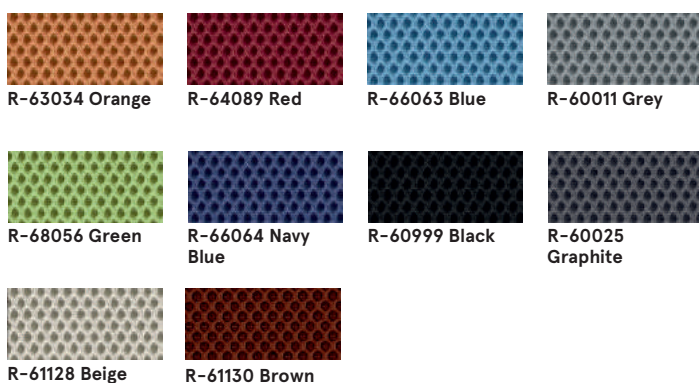

Technical data:

Material 80% polyester, 20% post-consumer recycled polyester
Fabric weight 510 g/lm (16.45 oz/lin.yd.)
Abrasion resistance rubs BS EN ISO 12947-2
 70,000 Martindale cycles
Pilling resistance scale 1-5, max 5, EN ISO 12945-2 (4-5)
Colour fastness to light scale 1-8, max 8, EN ISO 105-B02 (5-7)
Colour fastness to rubbing scale 1-5, max 5, EN ISO 105x12 (wet/dry) 4-5
Acoustic test sound absorption ISO 354
Flammability BS EN 1021-2 Match, CA TB 117-2013, BS EN 1021-1 (cigarette) Class Uno UNI 9175 Class 2, EMME

Fabric Medley - second price group

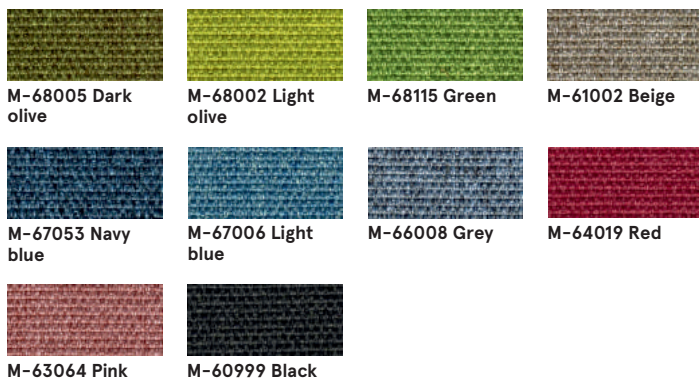

Technical data:

Material polyester 100%
Fabric weight 510 g/lm (16.45 oz/lin.yd.)
Abrasion resistance rubs BS EN ISO 12947-2, 75,000 cykli Martindale
Pilling resistance scale 1-5, max. 5, EN ISO 12945-2 (4)
Colour fastness to light scale 1-8, max. 8, EN ISO 105-B02 (5-7)
Colour fastness to rubbing scale 1-5, max. 5, EN ISO 105x12 (wet/dry (4-5/4-5))
Acoustic test sound absorption ISO 354
Flammability BS EN 1021-1 (cigarette) BS 476 Part 7, Class 2 Class Uno UNI 9174 - UNI 8457 CA TB 117-2013 ASTM E 84 Class I

Fabric Atlantic* - second price group



Technical data:

Material polyester 100%

Fabric weight 530 g/lm (17.09 oz/lin.yd.)

Abrasion resistance rubs BS EN ISO 12947-2, 110,000 Martindale cycles

Pilling resistance scale 1-5, max. 5, EN ISO 12945-2 (4-5)

Colour fastness to light scale 1-8, max. 8, EN ISO 105-B02 (5-7)

Colour fastness to rubbing scale 1-5, max. 5, EN ISO 105x12 (wet/dry)

Flammability CA TB 117-2013
ASTM E 84 Class I
BS EN 1021-2 (match)
BS EN 1021-1 (cigarette)

Fabric Vita - second price group



Technical data:

Material Surface: 98,5% PVC, 1,5% PU
Substrate: 50% polyester, 50% Cotton

Fabric weight 850g/m2 ± 10% (1190G/lin. m ± 10%)

Abrasion resistance rubs BS EN ISO 5470-2, 100,000 Martindale cycles

Colour fastness to light 6 (ISO 105 - B02)

Colour fastness to rubbing wet: 4, dry: 4 (ISO 105 - X12)

Flammability BS EN 1021 - (cigarette)
BS EN 1021 - 2 (match)
BS 5852 - (Ignition Source 5)
BS 7176 - (Medium Hazard)

Flexes BS EN ISO 7854 - Method B, 400.000 Flexing cycles

Anti-microbial / Anti-fungal AATCC 147

Fabric River - second price group



Technical data:

Material polyester 100%

Fabric weight 300g/m2 (+/- 5%)

Abrasion resistance rubs 100,000 Martindale cycles (EN ISO 12947-1,2)

Pilling resistance EN ISO 12945-2 (5)

Colour fastness to light 4 (EN ISO 105-B02)

Colour fastness to rubbing dry: 4-5, wet: 3 (EN ISO 105-x12)

Flammability BS 5852: Part 1, Ignition Source 0 (cigarette)
BS 5852: Part 1, Ignition Source 1 (match)
En1021 - 2

* There is a possibility of ordering the product in full colour spectrum of Atlantic range, as per Gabriel's pattern book, within 8 weeks

Fabric Xtreme - third price group



Technical data:

Material 100% Trevira Clame (CS)
100% Recykring (YS)
Flame Retardant polyester.
Non metallic dyestuffs.

Fabric weight 310 g/m2 ±5% (435g/lin.m ±5%)

Abrasion resistance rubs 60,000 Martindale cycles (CS)
100,000 Martindale cycles (YS)

Colour fastness to light 6 (ISO 105 - B02)

Colour fastness to rubbing wet: 4, dry: 4 (ISO 105 - X12)

Flammability EN 1021 - 1 (cigarette),
EN 1021 - 2 (match)
BS 7176 Low Hazard,
NF P92-507 M1, DIN 4102 B1,
UNI 9175 Class 1 IM, UNI 8456,
UNI 9174 & UNI 9177 Classe Uno,
ÖNORM B 3825 & A 3800-1
NF D 60-013

Fabric Synergy - third price group



Technical data:

Material 95% Virgin Wool, 5% Poliamid

Fabric weight 400g/m2 ±5% (560 g/lin.m ±5%)

Abrasion resistance rubs Independently certified
≥100,000 Martindale cycles

Colour fastness to light 5 (ISO 105 - B02)

Colour fastness to rubbing ISO 105 - X12 - wet: 4, dry: 4

Flammability EN 1021 - 1 (cigarette),
EN 1021 - 2 (match),
BS 7176 Low Hazard,
UNI 9175 Classe 1 IM,
ÖNORM B 3825 & A 3800-1

Fabric Silvertex – third price group

There is a possibility of ordering the product in full colour spectrum of Silvertex range, as per Spradling’s pattern book, within 15 working days.

Technical data:

Material	Topcoat: 100% Vinyl Backing: 100% Polyester Hi-Loft™
Fabric weight	685 gr/m2
Abrasion resistance	>300,000 cycles Martindale
UV-resistance	>= 7 (1000 hours, blue wool scale)
Cold Crack resistance	-23°C
Flame retardancy	NF P 92-503 / M2 EN 1021, Part 1&2 DIN 4102 B2 ÖNORM B 3825, Gruppe I – Schwerbrennbares Verhalten ÖNORM A 3800, Teil I, Qualmbildungsklasse QI – schwachqualmend IMO Res. MSC.307 (88) (2010 FTP Code) Annex I Part 8 (MED) Marine Equipment Directive in its current valid version UNI 9175 (1987) / UNI 9175/FAI (1994) Classe I.IM (uno I EMME) UNE 23.727-90 IR /M2 EN 71-2: 2006+AI: 2007 Safety of Toys – Part 2: Flammability ECE R 118 (replaces Directive 95/28/EC) FMVSS 302 FAR 25/853
Antimicrobial	Antifungal Protection, Antibacterial Protection, Antimycotic Protection

Fabric Atlas – fourth price group



Technical data:

Material	90% new wool, 10% nylon
Fabric weight	286g/m2, 400g/lm
Abrasion resistance rubs	100,000 cykli Martindale, EN ISO 12947
Colour fastness to light	ISO 105 B02: 6-7
Colour fastness to rubbing	ISO 105-X12:2001, (wet/dry) 4-5/4-5
Flammability	BS EN 1021-2 Match, BS EN 1021-1 Cigarette, BS 5 5852 Crib 5, BS 5852 ignition source 3, BS 5852 Part 1, NF D 60 013, UNI 9175 1IM, US Cal. Bull. 117-2013

Fabric Field2 – fourth price group



Technical data:

Material	100% Trevira CS
Fabric weight	321g/m2, 450g/lm
Abrasion resistance rubs	100,000 cykli Martindale, EN ISO 12947
Colour fastness to light	ISO 105 B02: 5-7
Flammability	BS EN 1021-2 Match, BS EN 1021-1 Cigarette, BS 5 5852 Crib 5, DIN 4102 B1 FAR 25.853, UNI 9177 classe 1, US Cal. Bull. 117-2013

Back, headrest



R-60999 Black

Armrest, castors



Black

Base



Black



Polished
aluminum *

* OPTION WITH EXTRA CHARGE