



KERN & Sohn GmbH

Ziegelei 1
D-72336 Balingen
E-Mail: info@kern-sohn.com

Phone: +49-[0]7433-9933-0
Fax: +49-[0]7433-9933-149
Internet: www.kern-sohn.com

Operating manual

Price calculating balance

KERN RFC

Type: RPB-DM
Version 1.2
2020-11
GB



RFC-BA-e-2012



KERN RFC

Version 1.2 2020-11

Operating manual

Price calculating balance

Contents

1	Technical data	4
1.1	Dimensions (mm)	6
2	Declaration of conformity	6
3	Appliance overview	7
3.1	Overview of display	8
3.2	Keyboard overview	10
4	Basic Information (General)	11
4.1	Proper use	11
4.2	Improper Use	11
4.3	Warranty	11
4.4	Monitoring of Test Resources	11
5	Basic Safety Precautions	12
5.1	Pay attention to the instructions in the Operation Manual.....	12
5.2	Personnel training.....	12
6	Transport and storage	12
6.1	Testing upon acceptance	12
6.2	Packaging / return transport	12
7	Unpacking, Setup and Commissioning	13
7.1	Installation Site, Location of Use	13
7.2	Unpacking.....	13
7.2.1	Placing.....	14
7.2.2	Scope of delivery / serial accessories:	14
7.3	Mains connection.....	14
7.4	Storage battery operation (optional).....	14
7.5	Initial Commissioning.....	15
7.6	Adjustment.....	15
7.7	Verification.....	18
7.7.1	Adjustment switch and seals	19
7.8	Checking the balance verification settings	19
8	The menu	20
8.1	Access to menu	20
8.2	Navigation in the menu:.....	20
8.3	Menu overview	21
9	Operation	23
9.1	Turn on/off	23
9.2	Zeroing	23
9.3	Weighing with tare	23
9.4	Overload warning	23
10	Weighing with price determination	24
10.1	Piece price entry via keyboard	24
10.2	Memory for piece price (PLU = Price look up)	25
11	Additional useful functions	27
11.1	Enter piece price and calculate the total price (without weighing)	27

11.2	AUTO CLEAR.....	27
11.3	Display background illumination.....	28
11.4	Units switch-over from € / kg ⇄ € / 100g.....	28
12	RS 232 interface	29
12.1	Technical data	29
12.2	Pin allocation of balance output bushing:.....	29
12.3	Remote control commands	29
12.4	Explanation of the data transfer	30
12.5	Print	30
13	Servicing, maintenance, disposal	31
13.1	Cleaning	31
13.2	Servicing, maintenance	31
13.3	Disposal.....	31
14	Instant help.....	32
14.1	Error messages	33

1 Technical data

Models without vertical display:

KERN (Typ)	RFC 6K3M	RFC 15K3M	RFC 30K3M
Trademark	RPB 6K1DM	RPB 15K2DM	RPB 30K5DM
Weighing range (max)	3 kg / 6 kg	6 kg / 15 kg	15 kg / 30 kg
Readability (d)	1 g / 2 g	2 g / 5 g	5 g / 10 g
Minimum load (Min)	20 g	40 g	100 g
Verification value (e)	1 g / 2g	2 g / 5g	5 g / 10 g
Verification class	III	III	III
Reproducibility	1 g / 2 g	2 g / 5 g	5 g / 10 g
Linearity	± 3 g / ± 6 g	± 2 g / ± 5 g	± 5 g / ± 10 g
Recommended adjusting weight (not supplied)	6 kg (M1)	15 kg (M1)	30 kg (M1)
Stabilisation time	2 s		
Heating time (operating temperature)	10 min		
Net weight (kg)	4.1 kg		
Piece price, can be switched over	€/kg; €/100 g		
Admissible ambient temperature	-10° C to 40° C		
Allowable air humidity	0 % - 80 % (non-condensing)		
Electric Supply	Mains adapter 220 V - 240 V AC, 50 Hz balance 12 V, 500 mA		
Rechargeable battery (optional)	6 V, 3.2 Ah		
	Operating time – background lighting OFF 60 hrs.		

Models with post-mounted display:

KERN (Typ)	RFC 6K3HM	RFC 15K3HM	RFC 30K3HM
Trademark	RPB 6K1DHM	RPB 15K2DHM	RPB 30K5DHM
Weighing range (max)	3 kg / 6 kg	6 kg / 15 kg	15 kg / 30 kg
Readability (d)	1 g / 2 g	2 g / 5 g	5 g / 10 g
Minimum load (Min)	20 g	40 g	100 g
Verification value (e)	1 g / 2 g	2 g / 5 g	5 g / 10 g
Verification class	III	III	III
Reproducibility	1 g / 2 g	2 g / 5 g	5 g / 10 g
Linearity	± 3 g / ± 6 g	± 6 g / ± 15 g	± 15 g / ± 30 g
Recommended adjusting weight (not supplied)	6 kg (M1)	15 kg (M1)	30 kg (M1)
Stabilisation time	2 s		
Heating time (operating temperature)	10 min		
Net weight (kg)	4.1 kg		
Piece price, can be switched over	€/kg; €/100 g		
Admissible ambient temperature	-10° C to 40° C		
Allowable air humidity	0 % - 80 % (non-condensing)		
Electric Supply	Mains adapter 220 V - 240 V AC, 50 Hz balance 12 V, 500 mA		
Rechargeable battery (optional)	6 V, 3.2 Ah		
	Operating time – background lighting OFF 60 hrs.		

1.1 Dimensions (mm)

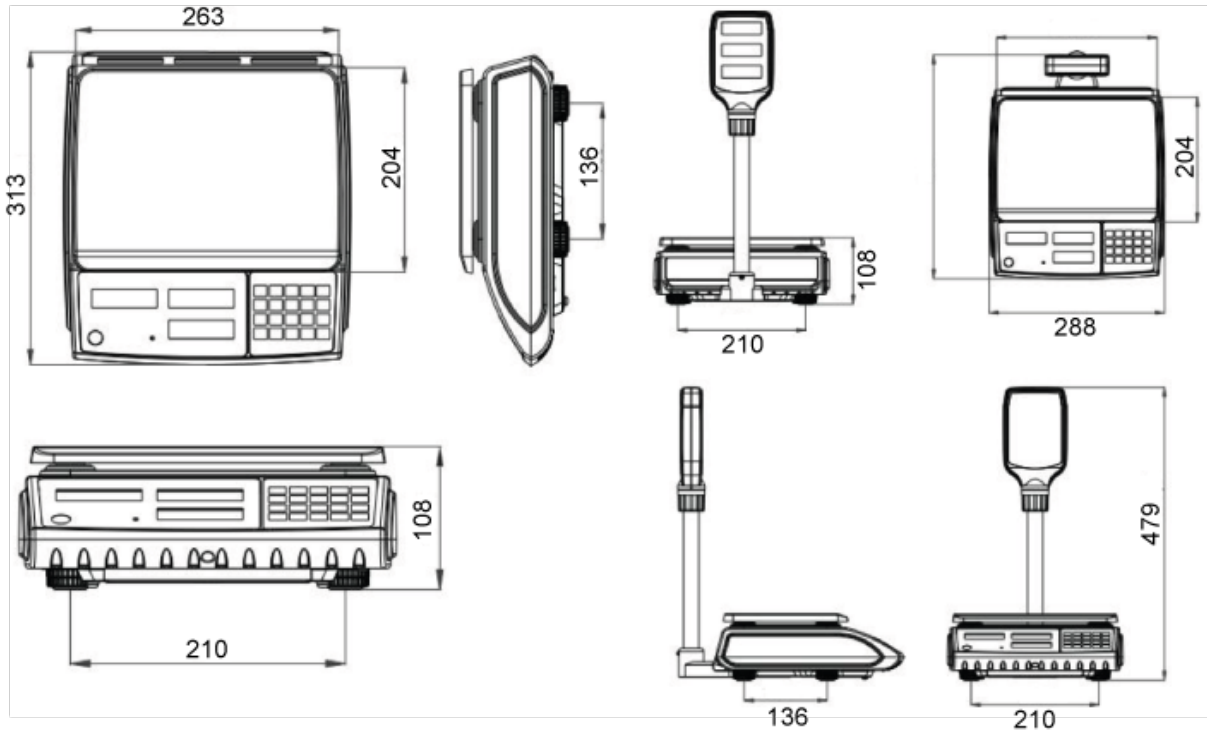

2 Declaration of conformity

The current EC/EU Conformity declaration can be found online in:

www.kern-sohn.com/ce

3 Appliance overview

Models without vertical display:



Models with post-mounted display:

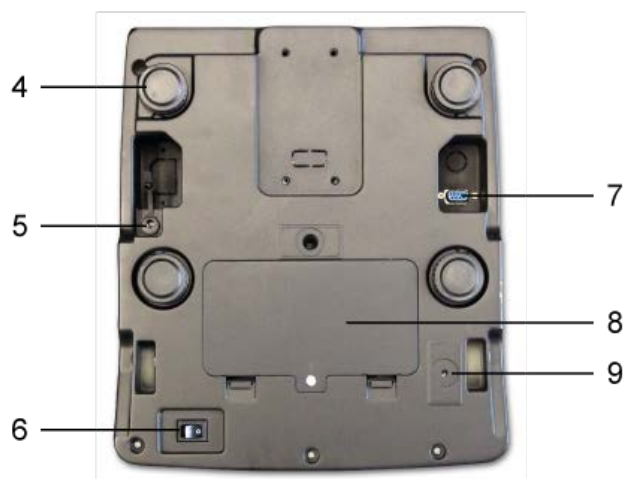

1. Weighing pan
2. Bubble level
3. Post-mounted display
4. Footscrews
5. Mains adapter connection
6. ON/OFF switch
7. RS 232 interface
8. Battery compartment
9. Adjustment switch

3.1 Overview of display

Operator and secondary display (standard on the backside of models without post-mounted display):

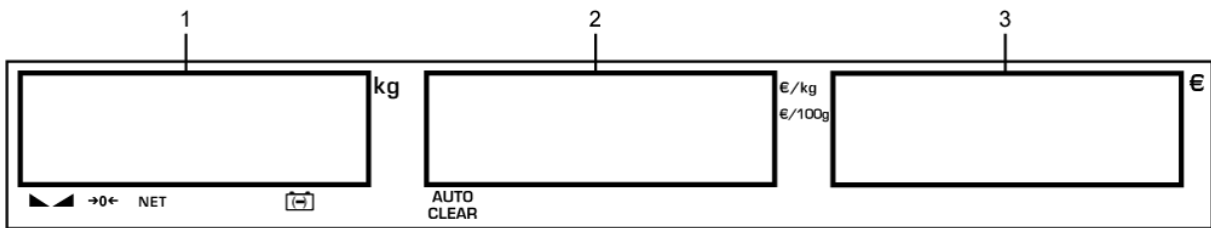
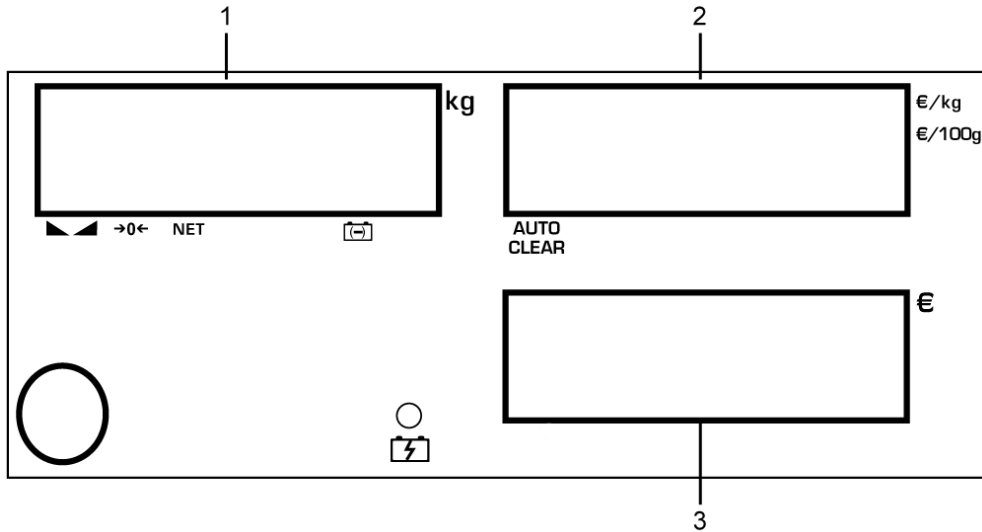

Additional post-mounted display for models with tripod:

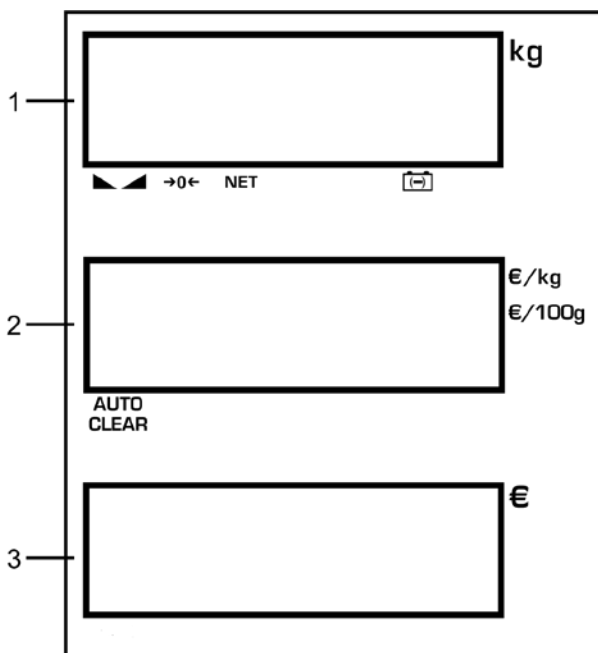



1. Weight
2. Piece price
3. Sales price

Display weight

Here, the weight of your goods is displayed.

Indicator ▼ next to symbol displays:

	Rechargeable battery very low
NET	Net weight
	Stability display
→0←	Zeroing display

Display piece price

Piece price, can be switched over from €/ kg or €/ 100 g.

Indicator ▼ next to symbol displays:

€/ kg	Piece price in €/kg
€/ 100 g	Piece price in €/100 g
AUTO CLEAR	Set piece price is deleted automatically when balance is unloaded

Display sale price

Here the sales price is displayed in Euro [€].

Battery loading status display

red	Charging storage battery
green	Rechargeable battery completely reloaded

3.2 Keyboard overview



Selection	Function
0 ~ 9	<ul style="list-style-type: none"> Numerical keys, PLU-keys In menu: Invoke parameter
C	<ul style="list-style-type: none"> Delete
PLU	<ul style="list-style-type: none"> Save piece price (press key for a long time), see chap. 10.2 Call-up piece price (press and hold key for a short time), see chap. 10.2
€ / kg ↔ € / 100g	<ul style="list-style-type: none"> Switch-over unit € / kg ↔ € / 100g
PRINT	<ul style="list-style-type: none"> Issue to external device In menu: Parameter selection
TARE	<ul style="list-style-type: none"> Taring, see chap. 9.3 In menu: Storing settings
AUTO CLEAR	<ul style="list-style-type: none"> For activated function, the set piece price is automatically deleted when the balance is unloaded.
€ / ⬇️	<ul style="list-style-type: none"> Enter piece price per piece (without weighing)
→0←	<ul style="list-style-type: none"> Zeroing In menu: Back to weighing mode
•	Depending on the operation mode (F4 PdESC): <ul style="list-style-type: none"> decimal point (PdESC FloAt) double zero (PdESC Fix)

4 Basic Information (General)

4.1 Proper use

The balance you purchased is intended to determine the weighing value of material to be weighed. It is intended to be used as a “non-automatic balance”, i.e. the material to be weighed is manually and carefully placed in the centre of the weighing pan. As soon as a stable weighing value is reached the weighing value can be read.

4.2 Improper Use

Do not use balance for dynamic weighing. In the event that small quantities are removed or added to the material to be weighed, incorrect weighing results can be displayed due to the “stability compensation“! (Example: Slowly draining fluids from a container on the balance.)

Do not leave permanent load on the weighing pan. This may damage the measuring system.

Impacts and overloading exceeding the stated maximum load (max) of the balance, minus a possibly existing tare load, must be strictly avoided. Balance may be damaged by this.

Never operate balance in explosive environment. The serial version is not explosion protected.

The structure of the balance may not be modified. This may lead to incorrect weighing results, safety-related faults and destruction of the balance.

The balance may only be used according to the described conditions. Other areas of use must be released by KERN in writing.

4.3 Warranty

Warranty claims shall be voided in case

- Our conditions in the operation manual are ignored
- The appliance is used outside the described uses
- The appliance is modified or opened
- Mechanical damage or damage by media, liquids, natural wear and tear
- The appliance is improperly set up or incorrectly electrically connected
- The measuring system is overloaded

4.4 Monitoring of Test Resources

In the framework of quality assurance the measuring-related properties of the balance and, if applicable, the testing weight, must be checked regularly. The responsible user must define a suitable interval as well as type and scope of this test. Information is available on KERN's home page (www.kern-sohn.com) with regard to the monitoring of balance test substances and the test weights required for this. In KERN's accredited DKD calibration laboratory test weights and balances may be calibrated (return to the national standard) fast and at moderate cost.

5 Basic Safety Precautions

5.1 Pay attention to the instructions in the Operation Manual



Carefully read this operation manual before setup and commissioning, even if you are already familiar with KERN balances.

5.2 Personnel training

The appliance may only be operated and maintained by trained personnel.

6 Transport and storage

6.1 Testing upon acceptance

When receiving the appliance, please check packaging immediately, and the appliance itself when unpacking for possible visible damage.

6.2 Packaging / return transport



- ⇒ Keep all parts of the original packaging for a possibly required return.
- ⇒ Only use original packaging for returning.
- ⇒ Prior to dispatch disconnect all cables and remove loose/mobile parts.
- ⇒ Reattach possibly supplied transport securing devices.
- ⇒ Secure all parts such as the glass wind screen, the weighing platform, power unit etc. against shifting and damage.

7 Unpacking, Setup and Commissioning

7.1 Installation Site, Location of Use

The balances are designed in a way that reliable weighing results are achieved in common conditions of use.

You will work accurately and fast, if you select the right location for your balance.

On the installation site observe the following:

- Place the balance on a firm, level surface;
- Avoid extreme heat as well as temperature fluctuation caused by installing next to a radiator or in the direct sunlight;
- Protect the balance against direct draughts due to open windows and doors;
- Avoid jarring during weighing;
- Protect the balance against high humidity, vapours and dust;
- Do not expose the device to extreme dampness for longer periods of time. Non-permitted condensation (condensation of air humidity on the appliance) may occur if a cold appliance is taken to a considerably warmer environment. In this case, acclimatize the disconnected appliance for ca. 2 hours at room temperature.
- Avoid static charge of goods to be weighed or weighing container.

If electro-magnetic fields or static charge occur, or if the power supply is unstable major deviations on the display (incorrect weighing results) are possible. In that case, the location must be changed.

7.2 Unpacking

Carefully remove the balance from the packaging, remove plastic cover and setup balance at the intended workstation.

7.2.1 Placing

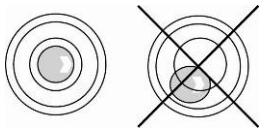

Level balance with foot screws until the air bubble of the water balance is in the prescribed circle.

7.2.2 Scope of delivery / serial accessories:

- Balance, see chap. 3
- Mains adapter
- Protective cover
- Operating manual

7.3 Mains connection

Power is supplied via the external mains adapter. The stated voltage value must be the same as the local voltage.

Only use KERN original mains adapter. Using other makes requires consent by KERN.

7.4 Storage battery operation (optional)

The optionally supplied battery is charged with the supplied power supply.

Before the first use, the battery should be charged by connecting it to the mains power supply for at least 15 hours.

- If an arrow [▼] appears on the weight display above the battery symbol , the capacity of the rechargeable battery will soon be exhausted. The balance will be ready to operate for about another 10 hours, then it will switch off automatically. Charge the battery with the help of the supplied power pack.
- If in the weight display appears „bat Lo“ followed by a flickering display, the capacity of the rechargeable battery is below the prescribed minimum. The balance will be ready to operate for about another 5 minutes, then it will switch off automatically. Charge the battery with the help of the supplied power pack.

The LED display informs you during loading about the loading status of the rechargeable battery.

red: Battery is almost discharged

green: Rechargeable battery completely reloaded

7.5 Initial Commissioning

In order to obtain exact results with the electronic balances, your balance must have reached the operating temperature (see warming up time chap. During this warming up time the balance must be connected to the power supply (mains, accumulator or battery).

The accuracy of the balance depends on the local acceleration of gravity. Strictly observe hints in chapter Adjustment.

7.6 Adjustment

As the acceleration value due to gravity is not the same at every location on earth, each balance must be coordinated - in compliance with the underlying physical weighing principle - to the existing acceleration due to gravity at its place of location (only if the balance has not already been adjusted to the location in the factory). This adjustment process must be carried out for the first commissioning, after each change of location as well as in case of fluctuating environment temperature. To receive accurate measuring values it is also recommended to adjust the balance periodically in weighing operation.

i The adjustment is locked for verified balances. Carrying out adjustment requires that the seal is destroyed and the adjustment switch is confirmed in step 3 when turning on the scale. For position of adjustment switch, see chap. 6.8.1

Attention:

After destruction of the seal the balance must be re-verified by an authorised agency and a new verification wire/seal mark fitted before it can be reused for applications subject to verification.

Procedure when adjusting:

Observe stable environmental conditions. A warming up time (see chapter 1) is required for stabilization. Ensure that there are no objects on the weighing pan. Arrange adjustment weight, details see chap.1 „Techn. data“

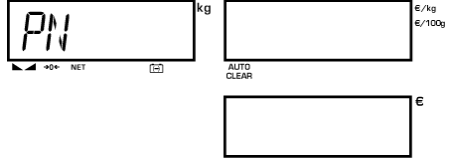
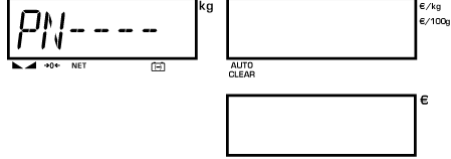
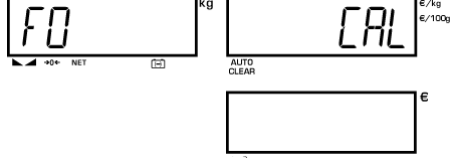
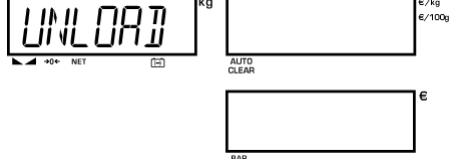
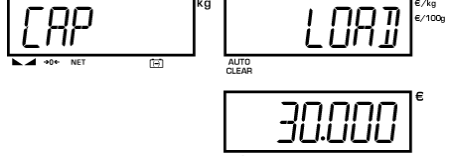
<p>To turn on/off operate the on/off switch at the underneath side on the right of the scale and keep pressed for a little while. During the selftest press TARE and keep pressed until Pn is displayed.</p>	
<p>Use the numeric keys to enter the standard password 0000. Pn---- is displayed.</p>	
<p>Confirm password with TARE, the adjustment function F0 CAL will be displayed.</p>	
<p>Press adjustment switch on the lower side of the balance.</p>	
<p>Press TARE, UnLoAd will be displayed. Ensure that there are no objects on the weighing pan.</p>	
<p>Press TARE again, CAP LOADxx will be displayed.</p>	 <p style="text-align: center;">(example)</p>

Set the displayed adjustment weight with the help

PRINT

of **PRINT**. Place the adjustment weight. Wait for the stability display appears,

TARE

then press **TARE**. PASS will be displayed.

Remove the adjustment weight. F0 CAL appears on the display. Now the process of adjustment is successfully completed.

using **→0←**

→0←

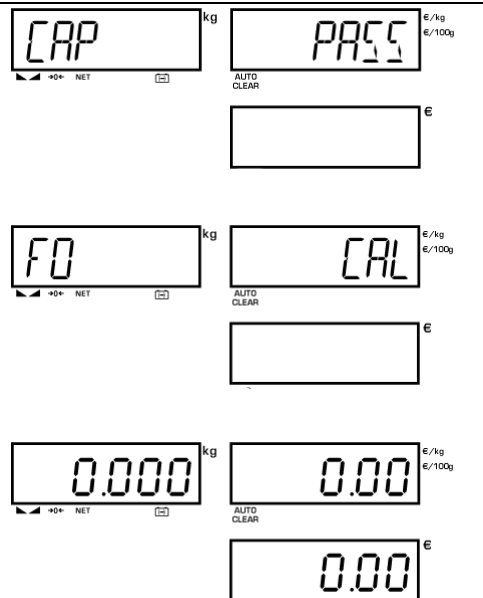

In case of an adjustment error or incorrect adjustment weight, the display will show an error message, then repeat adjustment process.

7.7 Verification

General hints:

According to EU directive 2014/31/EU balances must be officially verified if they are used as follows (legally controlled area):

- a) For commercial transactions if the price of goods is determined by weighing.
- b) For the production of medicines in pharmacies as well as for analyses in the medical and pharmaceutical laboratory.
- c) For official purpose.
- d) For manufacturing final packages.

In cases of doubt, please contact your local trade in standard.

After verification the balance is sealed at the indicated positions.

Verification of the balance is invalid without the "seals".

Verification notes

An EU type approval exists for balances described in their technical data as verifiable. If a balance is used where obligation to verify exists as described above, it must be verified and re-verified at regular intervals.

Re-verification of a balance is carried out according to the respective national regulations. The validity for verification of balances in Germany is e.g. 2 years.

The legal regulation of the country where the balance is used must be observed!

Balances with obligation to verify must be taken out of operation if:

- **The weighing result of the balance is outside the error limit.** Therefore, in regular intervals load balance with known test weight (ca. 1/3 of the max. load) and compare with displayed value.
- **The reverification deadline** has been exceeded.

7.7.1 Adjustment switch and seals

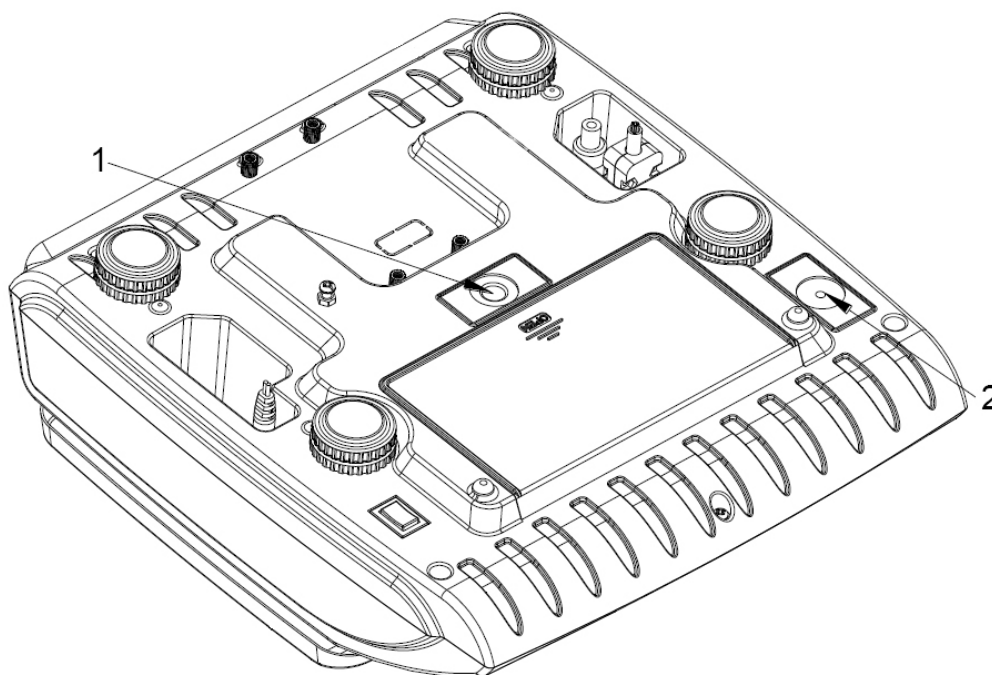

1. Seal of approval
2. Adjustment switch

7.8 Checking the balance verification settings

For the adjustment, the balance must be switched over to service mode.



In the service mode the parameters of the balance can be modified.
If this happened accidentally, please contact KERN.

In verified scales the service mode is locked individually for each switch. To disable the access lock, destroy the seal and actuate the switch.

Attention:

After destruction of the seal the balance must be re-verified by an authorised agency and a new verification wire/seal mark fitted before it can be reused for applications subject to verification.

8 The menu

8.1 Access to menu

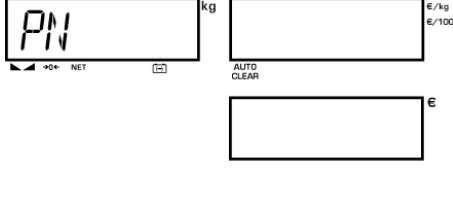
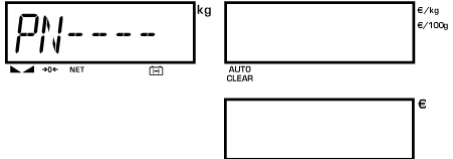
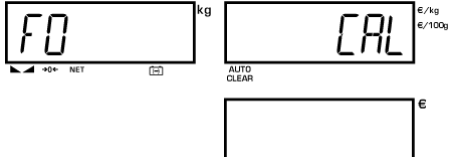
<p>To turn on/off operate the on/off switch at the underneath side on the right of the scale and keep pressed for a little while. During the selftest press TARE and keep pressed until the password inquiry "P in" appears.</p>	
<p>Using numeric keyboard, enter the standard password "0000". "P in ----" is displayed.</p>	
<p>Confirm with TARE password, the adjustment function F0 CAL will be displayed.</p>	
<p>Press adjustment switch on the lower side of the balance</p>	

8.2 Navigation in the menu:







Use the numeric keys **PRINT** or **PLU** to scroll up or down in the menu.

Confirm selected function by pressing **TARE**. Select desired setting with **PRINT** or **PLU** and acknowledge by **TARE**.

Exit menu:

Press the **→0←** button as often as necessary until the zero display appears. The balance is now again in weighing mode.

8.3 Menu overview

Function		Settings	Description
 or  and 		 or  and 	
F0	CAL		Adjustment function
F1	rES		Resolution
Press adjustment switch		rES dUAL-i	
		rES dUAL-r	
		3000	
		6000	
F2	CAP		Weighing range (max)
		30KG	
		3KG	
		6KG	
		15KG	
F3	PdECi		Decimal point price
		PdSL 0.00	
		PdSL 0.000	
		PdSL 0.0000	
		PdSL 0	
F4	PdESC		Decimal point — 2 functions
		PdESC Fix	The decimal point is always fixed (according to the settings of “ F3 PdECi ” function) and needs NOT be typed from the keyboard when entering the price. For this setting, the “ double zero function ” (i.e. “00” is entered) is allocated to the decimal point key on the display film.
		PdESC FLoAt	The decimal point should be typed after the price has been entered. For this setting, the “ decimal point function ” (i.e. this is the “.” character) is allocated to the decimal point key on the display film.
F5	SPEEd		A/D converter
		SLoW	
		MEdiuM	
		FASt	

F6	Min Coin		Interval size currency
		Coin 1 Coin	
		Coin 2 Coin	
		Coin 5 Coin	
		Coin 10 Coin	
F7	SCSiUE tArE		Multi-Tare function
		S tArE oFF	
		S tArE on	
F8	iSn		Internal value
		iSnxxxxx	
F9	GrA		Gravity
		GrA x.xxxxx	
F10	rESEt		Back to factory setting
F11	rS232		Interface RS232
	ModE	oFF	RS232 function disable
		com	Set RS232 interface to serial communication mode (Setting of the output protocol under menu item "Prot" is used)
		prt	Set RS232 interface fuction to print
	Port	Cont	Continues data transmission
		Ask	Protocol Type 1: Simple weighing commands
		KCP	Protocol Type 2: KCP
		DLG-06	Protocol Type 3: DLG-06
	Print	tPuP	Printout by pressing 
	bAUd		Baud rate
		9600	
		19200	
		38400	
		115200	
		1200	
		2400	
		4800	
	Pr		
		8n1	8 data bits, no parity, 1 stop bit
		7E1	7 data bits, even parity, 1 stop bit
		7o1	7 data bits, odd parity, 1 stop bit

9 Operation

9.1 Turn on/off

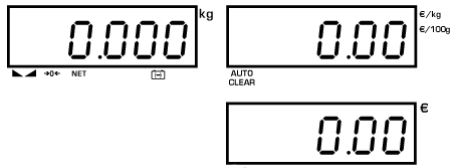
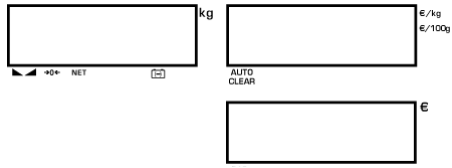
To turn on/off operate the on/off switch at the underneath side on the right of the scale and keep pressed for a little while. The balance will carry out a self-test As soon as the weight display shows "0" in all the three display windows your balance is ready to weigh.	
To switch-off push shortly to the right the switch-on/switch-out on the right lower side of the balance.	

9.2 Zeroing

Resetting to zero corrects the influence of light soiling on the weighing plate.

⇒ Unload the balance

⇒ Press , the balance starts resetting to zero. The indicator [▼] above →0← appears.

9.3 Weighing with tare

⇒ Deposit weighing vessel. When stability display appears, press . Zero display and the indicator [▼] above [NET] appear.

⇒ Weigh the material, the net weight will be indicated.

⇒ The weight of the weighing container will be displayed as a minus number after removing the weighing container.

⇒ To delete the tare value unload the weighing plate and press , the indicator [▼] above [GROSS] appears.

9.4 Overload warning



Overloading exceeding the stated maximum load (max) of the balance, minus a possibly existing tare load, must be strictly avoided. This could cause damage to the balance.

Exceeding maximum load is indicated by the display of „-OL-“, and an audio sound. Unload balance or reduce preload.

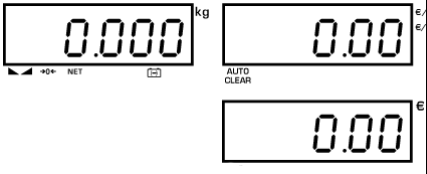
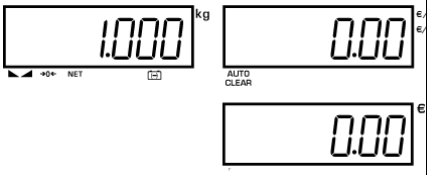

10 Weighing with price determination

As soon as the goods to be weighed are placed on the balance and the piece price has been set the price is calculated automatically and displayed in the provided field.

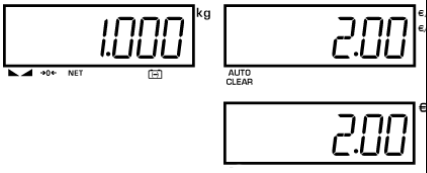
10.1 Piece price entry via keyboard

	
Place the weighing good, wait for stability display.	 <p>(example)</p>
Enter piece price via the numeric keys  to  The sales price will be calculated and displayed automatically.	 <p>(example)</p>

i

- The set piece price is deleted by .
- Using  switch over piece price from € / kg ↔ to € / 100g. (see chapter 11.1)
- Calculating the change, see chap. 10.3

10.2 Memory for piece price (PLU = Price look up)

The scale has 10 memory locations, which can be stored using the numeric keys



Save:

<p>Make sure that no weighing good is on the weighing plate and the scale stands on 0.</p>	
<p>Enter piece price via the numeric keys to .</p>	<p>(example)</p>
<p>Press and keep pressed, until SAVE PoS PS 0-9 is displayed. Here, the memory location can be entered.</p>	
<p>Using the numeric keys to select memory location, here is this example memory location 1. PLU 1 SAVED will be displayed briefly. Now the piece price is allocated to the memory location 1.</p>	

Retrieve / show sales price:

<p>Press . LOAD POS 0-9 is displayed.</p>	
<p>Invoke the stored memory location to (press to shortly). The piece price stored in the memory location is displayed. The balance is now ready for weighing.</p>	

Put items to be weighed, the sales price calculated from the saved piece price is displayed.

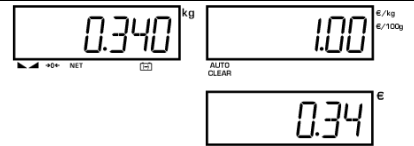

Before calling-up another PLU, the displayed piece price has to be deleted by



11 Additional useful functions

11.1 Enter piece price and calculate the total price (without weighing)

Enter piece price:

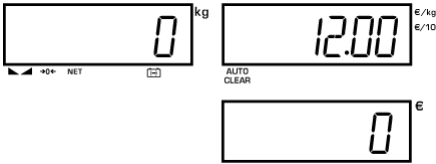
<p>Use the numeric keys to enter the piece price, in the example press 12.00. </p>	 <p>(example)</p>
---	---

Calculate the total price:

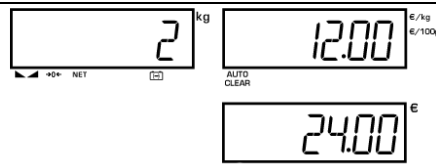
<p>Use the numeric keys to enter the number of pieces, the total price (e.g. 24.00) is calculated and displayed.</p>	 <p>(example)</p>
--	---

Return to weighing mode using 

11.2 AUTO CLEAR

Enable:

Unload the weighing plate and press , now the function is enabled. At the same time the arrow above "AUTO CLEAR" appears in the display. The set piece price is continues to be displayed after unloading the balance.

Disable:

⇒ Press  anew, the AUTO-CLEAR function will be deactivated, the arrow above „AUTO CLEAR“ will extinguish. When the item to be weighed is removed from the weighing plate, the set piece price will be automatically deleted.

11.3 Display background illumination

In weighing mode press  and keep pressed, until the background illumination type which has been set as last (p.ex. bLSET modE Auto) is displayed.

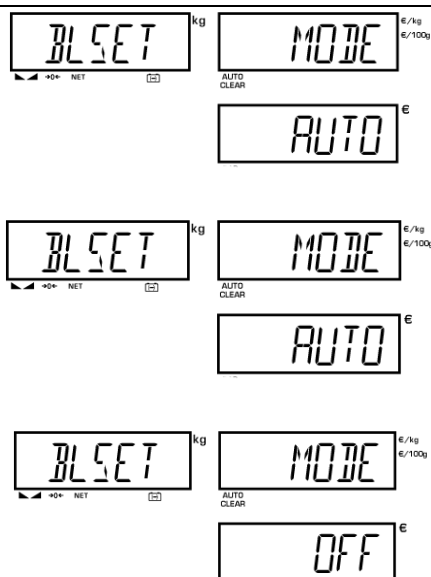

Use  to change between the settings Auto, On and Off.

To save the desired setting, press . The desired background illumination type is now set. The balance changes then automatically into weighing mode.

- on** Background illumination on
- off** Background illumination off
- Auto** Automatic background illumination only when weighing pate is loaded or key pressed.

11.4 Units switch-over from €/ kg ⇄ €/ 100g

Press  to change between the units kg and 100 g. The triangle in the piece-price display shows now the currently set unit.

12 RS 232 interface

12.1 Technical data

RS 232 connection to output of weighing data
 ASCII code
 Baud rate 1200 - 115200
 8 data bits
 No parity

12.2 Pin allocation of balance output bushing:

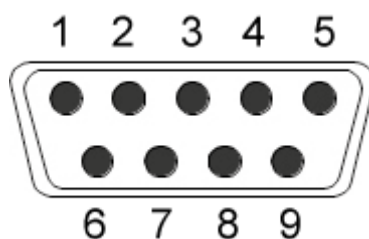

Pin 2	RXD	Input	Receiving data
Pin 3	TXD	Output	Transmission data
Pin 5	GND	—	Signal ground

9pin D Connector:

Balance		computer
Pin 2	—	Pin 3
Pin 3	—	Pin 2
Pin 5	—	Pin 5

12.3 Remote control commands

Remote control	Computer
T	Taring
Z	Zeroing
S	Output of stable weighing values
W	Output of stable or unstable weighing results

12.4 Explanation of the data transfer

S	T	,	G	S	:	-	/U						k	g	CR	LF
Header 1			Header 2			-WEIGHT DATA-						WEIGHT UNIT		TERMINATOR		

HEADER 1: ST=STABLE, US=UNSTABLE

HEADER 2: NT=NET, GS=GROSS

12.5 Print

Press  to output the weighing data via a connected printer:

Printout example:

2017/12/04 15:30:48

T (kg)	N (kg)	EUR/kg	C (EUR)

#0000	Apple		
0.5	0.538	1,99/ kg	1.071

C (EUR)	:		1.071

2017/12/04 15:30:48

T (kg)	N (kg)	EUR/g	C (EUR)

#0000	Apple		
0.5	0.538	1,99 /100 g	10,706

C (EUR)	:		10,706

2017/12/04 15:30:48

T (kg)	N (kg)	EUR/pcs	C (EUR)

#0000	Apple		
0.5	6 pcs	1,99 / pcs	11,94

C (EUR)	:		11,94

13 Servicing, maintenance, disposal

13.1 Cleaning

Before cleaning, please disconnect the appliance from the operating voltage.

Please do not use aggressive cleaning agents (solvents or similar agents), but a cloth dampened with mild soap suds. Ensure that no liquid penetrates into the device and wipe with a dry soft cloth.

Loose residue sample/powder can be removed carefully with a brush or manual vacuum cleaner.

Spilled weighing goods must be removed immediately.

13.2 Servicing, maintenance

The appliance may only be opened by trained service technicians who are authorized by KERN.

Before opening, disconnect from power supply.

13.3 Disposal

Disposal of packaging and appliance must be carried out by operator according to valid national or regional law of the location where the appliance is used.

14 Instant help

In case of an error in the program process, briefly turn off the balance and disconnect from power supply. The weighing process must then be restarted from the beginning.

Fault	Possible cause
The displayed weight does not glow.	<ul style="list-style-type: none">• The balance is not switched on.• The mains supply connection has been interrupted (mains cable not plugged in/faulty).• Power supply interrupted.• Batteries are inserted incorrectly or empty• No batteries inserted.
The displayed weight is permanently changing	<ul style="list-style-type: none">• Draught/air movement• Glass doors not closed• Table/floor vibrations• Weighing pan has contact with other objects.• Electromagnetic fields / static charging (choose different location/switch off interfering device if possible)
The weighing result is obviously incorrect	<ul style="list-style-type: none">• The display of the balance is not at zero• Adjustment is no longer correct.• The balance is on an uneven surface.• Great fluctuations in temperature.• Electromagnetic fields / static charging (choose different location/switch off interfering device if possible)

Should other error messages occur, switch balance off and then on again. If the error message remains inform manufacturer.

14.1 Error messages

-----	Load range exceeded – remove or reduce load
Err 4	Zero range exceeded
Err 5	Invalid entry
Err 6	Damaged electronics
Err 8	Adjustment error, check adjustment weight
Err 9	Instable; check environmental conditions
Err 19	Zero point drift; remove additional preloads (vessels) from the balance and adjust the scale
- - ol - -	Overload; remove the load and adjust the balance
--lo--	Underload; increase load