



KERN & Sohn GmbH

Ziegelei 1
D-72336 Balingen
E-Mail: info@kern-sohn.com

Tel: +49-[0]7433- 9933-0
Fax: +49-[0]7433-9933-149
Internet: www.kern-sohn.com

Operating instructions

Personal floor scale with BMI function

KERN MPC

Type MPC 250K100NM

Type MPC 300K-1M

Type MPC 300K-1LM

Version 1.1

2017-12

GB



MPC-BAPS-e-1711



KERN MPC

Version 1.1 2017-12

Operating instructions

Personal floor scale with BMI function

Contents

1	Technical data	4
2	Declaration of conformity	6
3	Appliance overview	6
4	Keyboard overview	8
5	Overview of display	9
6	Basic Information (General)	10
6.1	Proper use	10
6.2	Improper Use	11
6.3	Warranty	11
6.4	Monitoring of Test Resources	11
7	Basic Safety Precautions	12
7.1	Pay attention to the instructions in the Operation Manual	12
8	Transport and storage	12
8.1	Testing upon acceptance	12
8.2	Packaging / return transport	12
9	Unpacking, Setup and Commissioning	13
9.1	Installation Site, Location of Use	13
9.2	Unpacking	13
9.3	Scope of delivery	14
9.4	Balance assembly and installation	14
9.5	Mains connection	14
9.6	Battery operation is possible by obtaining an optional battery power pack.	15
9.7	Battery operation	15
9.8	Insert batteries/rechargeable batteries on the example of batteries:	16
9.9	Initial Commissioning	16
10	Operation	17
10.1	Weighing	17
10.2	Taring	17
10.2.1	Subsequent tare weight	18
10.3	HOLD function	18
10.4	Show second decimal place	18
10.5	Calculation of the Body Mass Index	19
10.5.1	Calculating Body Mass Index	19
10.5.2	Classification of BMI values	20
10.6	Automatic switch-off function „AUTO OFF“	21
10.7	Display background illumination	22
11	The menu	23
11.1	Navigation in the menu	23
11.2	Menu overview	24

11.2.1	Models without RS232 interface	24
11.2.2	Models with RS232 interface (option)	25
12	Data output RS 232	27
12.1	Pin allocation of balance output bushing:	27
12.2	Technical data	27
12.3	Printer operation	28
13	Error messages	29
14	Service, maintenance, disposal	30
14.1	Cleaning	30
14.2	Cleaning / disinfecting	30
14.3	Sterilisation	30
14.4	Service, maintenance	30
14.5	Disposal	30
15	Instant help	31
16	Adjustment	33

1 Technical data

KERN (Type)	MPC 250K100NM
Trademark	MPC 250K100M
Display	6-digit
Weighing range (max)	250 kg
Reproducibility	0.1 kg
Linearity \pm	0.1 kg
Display	LCD with 25mm high digits
Recommended adjustment weight, (Class)	≥ 200 kg (M1)
Stabilization time (typical)	3 sec.
Warm-up time	10 min
Operating temperature	0° C + 40° C
Humidity of air	max. 80 % (not condensing)
Electric Supply	Input voltage 100 V - 240 V, 50 / 60 Hz
Weighing plate mm	365 x 370 x 80
Weight kg (net)	8.4
Wall bracket	✓
Rechargeable battery operation	optional; 6 x 1.2 VAA = 7.2 V/2000 mA
Batteries	6 x 1.5 V AA
Data interface provided as standard	RS 232 C (optional)



KERN (Type)	MPC 300K-1M	MPC 300K-1LM
Display	6-digit	6-digit
Weighing range (max)	300 kg	300 kg
Reproducibility	0.1 kg	0.1 kg
Linearity \pm	0.1 kg	0.1 kg
Display	LCD with 25mm high digits	
Recommended adjustment weight, (Class)	≥ 300 kg (M1)	
Stabilization time (typical)	3 sec.	
Warm-up time	10 min	
Operating temperature	0° C + 40° C	
Humidity of air	max. 80 % (not condensing)	
Electric Supply	Input voltage 100 V - 240 V, 50 / 60 Hz	
Weighing plate mm	365 x 370 x 80	400 x 500 x 120
Weight kg (net)	9.0	10.0
Wall bracket	✓	
Rechargeable battery operation	optional; 6 x 1.2 VAA = 7.2 V/2000 mA	
Batteries	6 x 1.5 V AA	
Data interface provided as standard	RS 232 C (optional)	

2 Declaration of conformity

To view the current EC/EU Declaration of Conformity go to:

www.kern-sohn.com/ce

3 Appliance overview



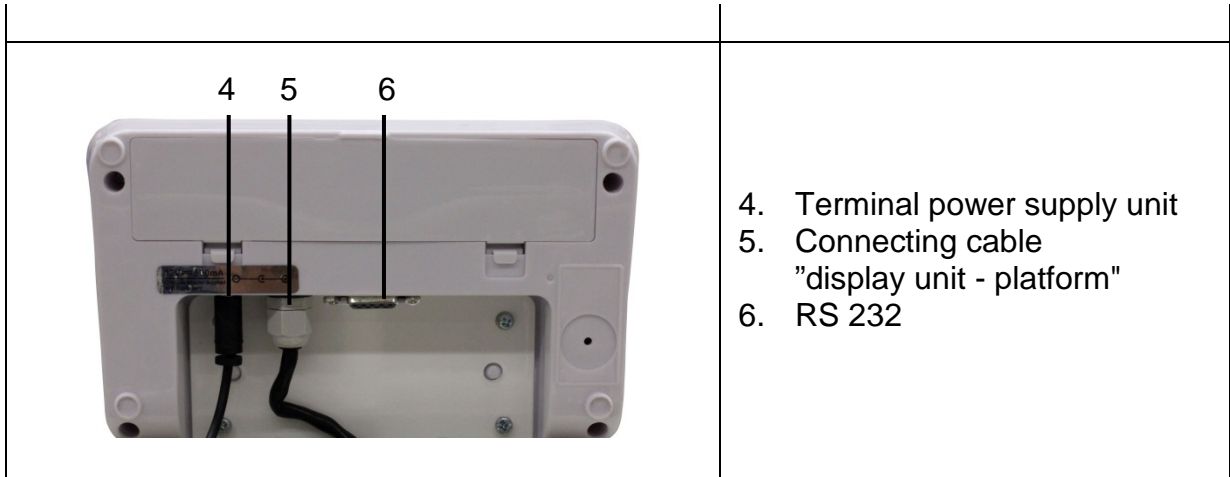

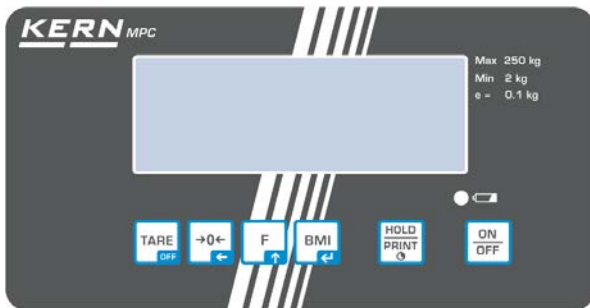

 <p>e.g. MPC 250K100NM</p>	<p>1. Weighing platform (anti-slip surface)</p>
<p>Underside</p>  <p>e.g. MPC 250K100NM</p>	<p>2. Rubber feet (height adjustable) 3. Bubble level</p>





4 Keyboard overview



Type MPC 250K100NM

Key	Description	Function
	ON/OFF-switch	Turn on/off
	HOLD button	Hold function/Calculation of a stable weight value
	BMI key	Calculation of the Body Mass Index In menu: <ul style="list-style-type: none"> • Confirm selection For numeric entry: <ul style="list-style-type: none"> • Confirm numerical value
	Function key	In menu: <ul style="list-style-type: none"> • Call up menu • How to select menu items For numeric entry: <ul style="list-style-type: none"> • Increase numerical value
	Zeroing key	Weighing scale will be reset to „0.0“ For numeric entry: <ul style="list-style-type: none"> • Change decimal place
	TARE key	Tare balance

5 Overview of display

Display	Description	Description
	Stability display	Scales are in a steady state
	Zeroing display	Should the balance not display exactly zero despite empty weighing plate, press the  button. Your balance will be set to zero after a short standby time.
NET	Net weight display	Illuminated when net weight is displayed Illuminated after weighing scale was tared
GROSS	Gross weight display	Illuminated when gross weight is displayed
HOLD	HOLD function	HOLD function active
BMI	BMI function	Illuminated while BMI function is enabled

6 Basic Information (General)

6.1 Proper use

These scales are used to determine weight of people standing at rest, The person should be weighed carefully and have contact with the center of the weighing plate, stand and stay calm.

As soon as a stable weighing value is reached the weighing value can be read. The scales are designed for long-term usage.

Determination of the body weight.

Use as „non-standalone weighing scale“, that is, a person sits carefully onto the seating surface's centre. Once a steady display value is shown, you can read the weight value.



The weighing platform may only be stepped on by persons capable of standing on both feet on the weighing platform.

according to this symbol:



The weighing platforms are fitted with an anti-slip surface that must not be covered during weighing a person.

The balance should be checked for correct condition prior to each utilisation by a person familiar with proper operation of the balance.

6.2 Improper Use

Do not use these scales for dynamic weighing processes.

Do not leave permanent load on the weighing pan. This may damage the measuring system.

Impacts and overloading exceeding the stated maximum load (max) of the weighing plate, minus a possibly existing tare load, must be strictly avoided. This could cause damage to the balance.

Never operate balance in explosive environment. The serial version is not explosion protected. It should be noted that a flammable mixture of anaesthetics and oxygen or laughing gas may occur.

The structure of the balance may not be modified. This may lead to incorrect weighing results, safety-related faults and destruction of the balance.

The balance may only be used according to the described conditions. Other areas of use must be released by KERN in writing.

The balance cannot be used to determine a body weight in practice of medicine.

6.3 Warranty

Warranty claims shall be voided in case

- Our conditions in the operation manual are ignored
- The appliance is used outside the described uses
- The appliance is modified or opened
- Mechanical damage and damage caused by media, liquids,
- Natural wear and tear
- The appliance is improperly set up or incorrectly electrically connected
- The measuring system is overloaded
- Dropping the balance

6.4 Monitoring of Test Resources

In the framework of quality assurance the measuring-related weighing properties of the balance and, if applicable, the testing weight, must be checked regularly. The responsible user must define a suitable interval as well as type and scope of this test. Information is available on KERN's home page (www.kern-sohn.com) with regard to the monitoring of balance test substances and the test weights required for this. In KERN's accredited DKD calibration laboratory test weights and balances may be calibrated (return to the national standard) fast and at moderate cost.

Using measuring technology to check the accuracy of the measuring device is recommended for personal floor scales with body height measurement but is not absolutely essential as the calculation of the human body height is always subject to a great deal of inaccuracy.

7 Basic Safety Precautions

7.1 Pay attention to the instructions in the Operation Manual

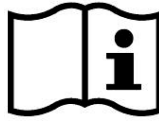
	⇒ Carefully read this operation manual before setup and commissioning, even if you are already familiar with KERN balances.	
---	---	---

8 Transport and storage

8.1 Testing upon acceptance

When receiving the appliance, please check packaging immediately, and the appliance itself when unpacking for possible visible damage.

8.2 Packaging / return transport



- ⇒ Keep all parts of the original packaging for a possibly required return.
- ⇒ Only use original packaging for returning.
- ⇒ Prior to dispatch disconnect all cables and remove loose/mobile parts.
- ⇒ Reattach possibly supplied transport securing devices.
- ⇒ Secure all parts such as the weighing platform, power unit etc. against shifting and damage.

9 Unpacking, Setup and Commissioning

9.1 Installation Site, Location of Use

The balances are designed in a way that reliable weighing results are achieved in common conditions of use.

You will work accurately and fast, if you select the right location for your balance.

On the installation site observe the following:

- Place scales on a stable, even surface;
- Avoid extreme heat as well as temperature fluctuation caused by installing next to a radiator or in the direct sunlight;
- Protect the balance against direct draughts due to open windows and doors;
- Avoid jarring during weighing;
- Protect the balance against high humidity, vapours and dust;
- Do not expose the device to extreme dampness for longer periods of time. Non-permitted condensation (condensation of air humidity on the appliance) may occur if a cold appliance is taken to a considerably warmer environment. In this case, acclimatize the disconnected appliance for ca. 2 hours at room temperature.
- Avoid static charge of the balance and of the person to be weighed.
- Avoid contact with water.

Major display deviations (incorrect weighing results) may be experienced should electromagnetic fields (e.g. due to mobile phones or radio equipment), static electricity accumulations or instable power supply occur. Change location or remove source of interference.

9.2 Unpacking

Remove the individual components of the balance or the complete balance from the packaging with care and install at the intended location. When using the power pack, ensure that the power cable does not produce a risk of stumbling.

9.3 Scope of delivery

Serial accessories:

- Balance
- Power pack unit
- Operating instructions
- Wall bracket
- Protective working cover

9.4 Balance assembly and installation

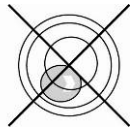

⇒ Level balance with foot screws until the air bubble of the water balance is in the prescribed circle.

⇒ Check levelling regularly.

The MPC model is supplied fully assembled (apart from wall bracket)

9.5 Mains connection

Power is supplied by the external power unit which also serves to isolate the mains supply from the scale. The stated voltage value must be the same as the local voltage.

Only approved KERN original mains adapters are to be used.

The small sticker attached to the side of the display unit indicates the power port:



The LED remains illuminated as long as the weighing scale remains connected to the mains.

The LED display informs you during loading about the loading status of the rechargeable battery.

green: Rechargeable battery is completely discharged

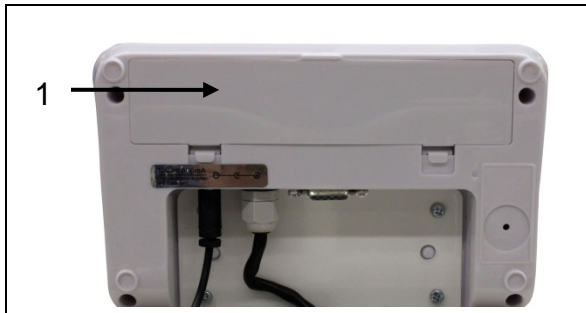

blue: Charging rechargeable battery

9.6 Battery operation is possible by obtaining an optional battery power pack.



Open the battery compartment cover (1) at the base of the display unit and insert the rechargeable battery. Charge the battery for at least 12 hours before initial use.

The appearance of the symbol  in the weight display indicates that the battery is almost exhausted. The weighing scale will remain ready for operation for a few more minutes before switching off in order to save battery (s. chap. 11.6 Auto off). Load rechargeable battery.



-  Voltage has dropped below prescribed minimum.
-  Rechargeable battery very low.
-  Rechargeable battery completely reloaded

If the balance is not used for a longer time, take out the rechargeable battery and store it separately. Leaking liquid could damage the balance.



9.7 Battery operation

As an alternative to rechargeable battery operation, the balance may also be operated with 6x AA batteries.

Open battery compartment cover (1) at the lower side of the display unit and insert batteries according to the example below. Lock the battery cover again. If the batteries are empty, in the balance display appears the symbol . Change batteries. To save battery power, the balance switches off automatically (see chap.11.6 Auto off).

-  Capacity of batteries exhausted.
-  Batteries will soon be flat.
-  Batteries are completely charged

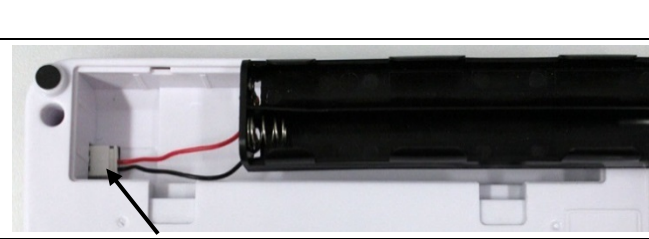
9.8 Insert batteries/rechargeable batteries on the example of batteries:

Remove battery compartment cover	
Connect battery holder to housing contact acc. to illustration	
Insert battery holder	
Insert batteries into battery compartment and lock with battery compartment cover.	

9.9 Initial Commissioning

In order to obtain exact results with the electronic balances, your balance must have reached the operating temperature (see warming up time chap. 1). During this warming up time the balance must be connected to the power supply (mains, accumulator or battery) and be switched on.

The accuracy of the balance depends on the local acceleration of gravity. The value of gravity acceleration is shown on the type plate.

10 Operation

10.1 Weighing



- ⇒ Start balance by pressing . The balance will carry out a self-test. The scales are ready for operation as soon as the weight display for "0.0 kg" has appeared.



- However, you can reset the weighing scale to zero by pressing the  key.

- ⇒ Have person stand in the centre of the scales. Wait until the standstill display „STABLE“ appears, then read the weighing result.



- If the person is heavier than the weighing range, "OL" (=overload) will appear in the display.

10.2 Taring

The tare weight of any preloads can be deducted by pressing a button so that the actual weight of the person is displayed in subsequent weighings.

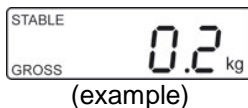

- ⇒ Put object (such as towel or padding) on the weighing pan.

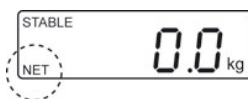

- ⇒ Press , the zero display appears. „NET“ is shown at the bottom on the left.

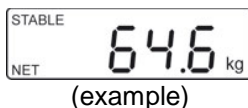

- ⇒ Allow the person to step onto the centre of the weighing platform. Wait until the standstill display „STABLE“ appears, then read the weighing result.



- When the balance is unloaded the saved taring value is displayed with negative sign.
- To delete the stored tare value, release scales and press .

10.2.1 Subsequent tare weight

The balance can be tared several times successively.

10.3 HOLD function

The balance has an integrated standstill function (mean value calculation). With this function it is possible to weigh people accurately even if they do not stand still on the weighing plate.

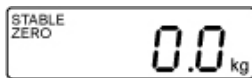

⇒ Start balance by pressing . Wait for stability display „STABLE“ to appear.

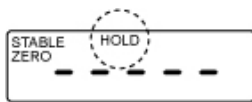

⇒ Press  in the display „-----“ will appear and the „HOLD“ symbol appears.

⇒ Allow the person to step onto the centre of the weighing platform.

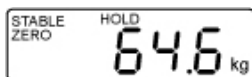

(Example)

⇒ After a short time the stability display „STABLE“ appears and the weighing value of the person is displayed and „frozen“.

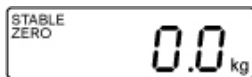

After unloading the balance, the weighing value remains displayed for approx. 10 seconds, then the balance changes automatically into the weighing mode. The symbol „HOLD“ disappears.



There is no average value calculation in the event of too much movement.

10.4 Show second decimal place

Press  and hold for about 2 s whilst weighed result is being shown. The second decimal place will be shown for approx. 5 s.

10.5 Calculation of the Body Mass Index

You need to know a person's body height before you can calculate the BMI for that person. It should either be known.

10.5.1 Calculating Body Mass Index

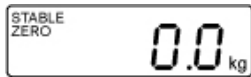

⇒ Start balance by pressing 

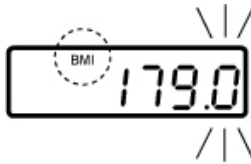

⇒ Wait for stability display „STABLE“ to appear.



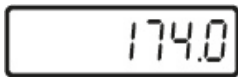

⇒ Press or 

The most recently entered body height will be shown with the enable digit flashing. The „BMI“ symbol lights up.

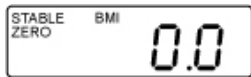

⇒ To enter body height, press the  and  key.



⇒ Confirm your entered value by pressing . BMI „0.0“ is displayed

⇒ Allow the person to step onto the centre of the weighing platform.



„-----“, is shortly displayed, followed by the BMI value of the person.

⇒ Unload weighing plate

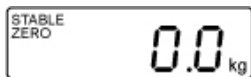

⇒ To return to weighing mode, press . The BMI symbol will disappear and the kg display will reappear.



- Reliable calculation of BMI is restricted to a body height of 100 cm to 200 cm and a weight of >10 kg.
- If weighing has to take place under unsteady conditions, you can stabilise the display by applying the Hold function.

10.5.2 Classification of BMI values

Weight classification for adults over 18 years of age using the BMI in accordance with WHO, 2000 EK IV and WHO 2004.

Categorie	BMI (kg/m²)	Risk of diseases associated with overweight
Underweight	< 18.5	low
Normal weight	18.5 – 24.9	Average
Overweight	≥ 25.0	
Pre-adipose	25.0 – 29.9	A bit high
Adipose degree I	30.0 – 34.9	High
Adipose degree II	35.0 – 39.9	up
Adipose degree III	≥ 40	Very high

10.6 Automatic switch-off function „AUTO OFF“

The weighing scale will switch off automatically after the allotted time as long as neither the display unit nor the weighing plate is operated.

i • Menu settings:
[F1 oFF] ⇒ **[oFF 0/3/5/15/30]** (see chap. 12)



⇒ Start balance by pressing 

⇒ Wait for stability display „STABLE“ to appear.



⇒ Press , **[F1 oFF]** is displayed

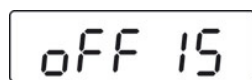

(example)

⇒ Press  to display the most recently set time, such as **[oFF 15]**

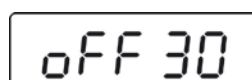

(example)

⇒ Press  repeatedly until the desired time is displayed, e.g. **[oFF 30]**

[oFF 0]	AUTO OFF - function disabled
[oFF 3]	Weighing system will be turned off after 3 min.
[oFF 5]	Weighing system will be turned off after 5 min.
[oFF 15]	Weighing system will be turned off after 15 min.
[oFF 30]	Weighing system will be turned off after 30 min.



⇒ Use  to save the selected time, **[F1 oFF]** will be displayed



⇒ Return to weighing mode using 

10.7 Display background illumination

- 
 • Menu settings:
[F4 or F2 bk] ⇒ **[bL on / bL off / bL AU]** see chap. (12)



⇒ Start balance by pressing .

⇒ Wait for stability display „STABLE to appear.



⇒ Press , **[F1 OFF]** is displayed

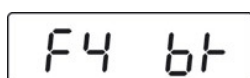

⇒ Press  repeatedly until **[F4 bk]** is shown.

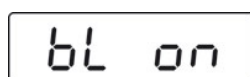

⇒ To display the most recent setting such as **[bL on]**, press



(example)





⇒ To select the desired setting, press .

bL on Continuous background lighting

bL off Background illumination off

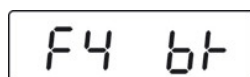
bL Auto Automatic background illumination on when weighing plate is loaded or key pressed.









⇒ To save the selected setting, press  and **[F4 bk]** will be displayed.



⇒ Return to weighing mode using .





11 The menu

11.1 Navigation in the menu



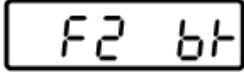
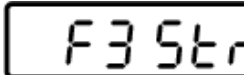
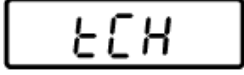

Call up menu	⇒ In weighing mode, press  and the first function [F1 OFF] will be displayed.
Select function	⇒ With help of  , the individual functions can be selected one after the other.
Change settings	⇒ Confirm selected function by pressing  . The current setting will be displayed. ⇒ To select the desired setting, press  and confirm your selection by  ; the weighing scale will return to the menu.
Exit menu/ Return to weighing mode	⇒ Press  and the scales will return to weighing mode.

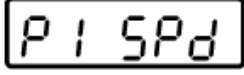
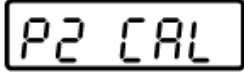
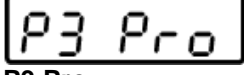



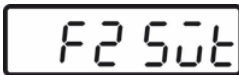
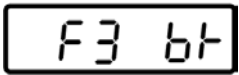
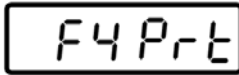



11.2 Menu overview

11.2.1 Models without RS232 interface

Function	Settings	Description
 F1 oFF Automatic cutout Auto Off	oFF 0*	Automatic shutdown off
	oFF 3	Automatic shutdown after 3 min
	oFF 5	Automatic shutdown after 5 min
	oFF 15	Automatic shutdown after 15 min
	oFF 30	Automatic shutdown after 30 min
 F2 bk Background illumination of display	bl on	Back lighting for display on
	bl oFF	Display background illumination off
	bl AU*	Backlighting for display will come on automatically as soon as the weighing scale is operated.
 F3 Str Subsequent tare value locked in devices with type approval certificate.	Str on	Following tare ON
	Str oFF*	Following tare OFF
 tCH Service menu	Pin	Password Input. Press  ,  ,  subsequently.
Operate adjustment switch; for position see chap.17		
 P1 Spd Display speed	15*	Not documented
	30	
	60	
	7.5	
 P2 CAL	Adjustment, see chap. 18	
 P3 Pro	tri*	Not documented
	CoUnt	Not documented
	rESEt	Reset weighing scale to factory setting
	SEtGrA	Not documented

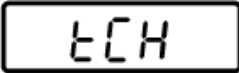
11.2.2 Models with RS232 interface (option)

Function	Settings	Description
 Automatic cutout Auto Off	oFF 0*	Automatic shutdown off
	oFF 3	Automatic shutdown after 3 min.
	oFF 5	Automatic shutdown after 5 min.
	oFF 15	Automatic shutdown after 15 min.
	oFF 30	Automatic shutdown after 30 min.
 Background illumination of display	oFF*	Not documented
	Prt	
	Pr ACC	
 Background illumination of display	bl on	Back lighting for display on
	bl oFF	Display background illumination off
	bl AU*	Backlighting for display will come on automatically as soon as the weighing scale is operated.
 Interface parameter	1. RS-232 mode Select desired mode by  , then confirm with  .	
	P Prt	Weight will be added to summation memory and printed after pressing PRINT (long press)
	P Cont	Continuous data output
	Series	Not documented
	ASK	Remote control instructions: W: Send all weighing details S: Send stable weight value T: Taring Z: Zeroing
	P cnt 2	Not documented
	P Stab	Automatic data output of stable weighing values
	P Auto	Weighed result will be added automatically to summation memory and issued
	2. Baud rate The currently set baud rate (b xxx) will be shown after the RS-232 mode was confirmed. Select desired Baudrate by pressing  and confirm by  . Available Baud rate: 600, 1200, 2400, 4800, 9600	

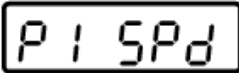
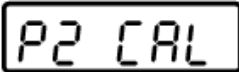
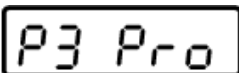
<p>3. Data output format (Setting P Prt, P Auto, P Cont only!) The currently set data output format will be displayed after the Baud rate has been confirmed. Select desired format by  and confirm with .</p>									
only at setting P Prt, P	Prt 0-3 Data output format, see chap. 13.3								
Only when set P Cont	Cont 1 Default Sd0 – on/off Continuous data output, selectable “Sending 0” yes / no								
	Cont 2 Not documented								
	Cont 3 Not documented								
<p>4. Printer type The currently set printer type will be displayed after the data output format has been confirmed. Select desired printer type by pressing  and confirm with .</p>									
LP 50	Not documented								
tPUP	Use this setting								
<p> Pin Password Input: Press , ,  subsequently. Operate adjustment switch; for position see chap.17</p>									
<p> Display speed</p>	<table border="1"> <tr> <td>15*</td> <td rowspan="4">Not documented</td> </tr> <tr> <td>30</td> </tr> <tr> <td>60</td> </tr> <tr> <td>7.5</td> </tr> </table>	15*	Not documented	30	60	7.5			
15*	Not documented								
30									
60									
7.5									
<p> Adjustment, see chap. 18</p>									
<p></p>	<table border="1"> <tr> <td>tri*</td> <td>Not documented</td> </tr> <tr> <td>CoUnt</td> <td>Not documented</td> </tr> <tr> <td>rESEt</td> <td>Reset weighing scale to factory setting</td> </tr> <tr> <td>SEtGrA</td> <td>Not documented</td> </tr> </table>	tri*	Not documented	CoUnt	Not documented	rESEt	Reset weighing scale to factory setting	SEtGrA	Not documented
tri*	Not documented								
CoUnt	Not documented								
rESEt	Reset weighing scale to factory setting								
SEtGrA	Not documented								

12 Data output RS 232

You can print weighing data automatically via the RS 232 interface or manually by pressing  via the interface according to the setting in the menu.

This data exchange is asynchronous using ASCII - Code.

The following conditions must be met to provide successful communication between the weighing balance and the printer.

- Use a suitable cable to connect the weighing balance to the interface of the printer. Faultless operation requires an adequate KERN interface cable.
- Communication parameters (baud rate, bits and parity) of balance and printer must match.

12.1 Pin allocation of balance output bushing:

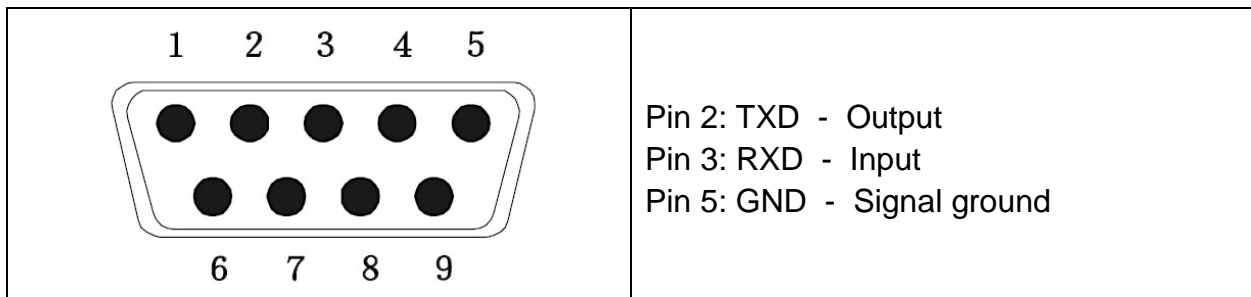

12.2 Technical data

Connection	9 pin d-subminiature bushing Pin 2 output Pin 3 input Pin 5 signal earth
Baud rate	Optional 600/1200/2400/4800/9600
Parity	8 bits,

12.3 Printer operation

Printout examples:

Prt	
0 / 2	60.0kg
1 / 3	60.0kg 170.0cm 20.7BMI

Remote control instructions:

S:				
29.03.2017	09:31:21:	ST	20.0 kg	Stable positive value
29.03.2017	09:31:55:	ST	-20.0 kg	Stable negative value

W:				
29.03.2017	09:32:12:	US	44.3 kg	Instable positive value
29.03.2017	09:32:38:	US	-18.4 kg	Instable negative value

13 Error messages

Display

Description

Err4

Zero range exceeded

(on start-up or when pressing the  key)

- Load on weighing pan
- Excess load, during zero setting of weighing scale
- Incorrect adjusting process
- Fault on load cell

Err6

Value outside the A/D converter range

- Damaged weighing cell
- Damaged electronics

Err 19

Lack of possibility of zero point initiation

- Damaged / overloaded measuring cell
- The objects are located on the platform / have contact with it
- Unremoved transportation protection
- Main Board damaged

Should other error messages occur, switch balance off and then on again. If the error message remains inform manufacturer.

14 Service, maintenance, disposal

14.1 Cleaning



Before any maintenance, cleaning and repair work disconnect the appliance from the operating voltage.

14.2 Cleaning / disinfecting

Clean weighing platform (such as seat) as well as casing with household detergents or commercially available disinfectants, e.g. 70% isopropanol. We recommend a disinfectant suitable for wiping disinfection. Please follow manufacturer's instructions.

Do not use abrasive or aggressive cleaners such as spirits or alcohol or similar as they might damage the high-quality surface.

To prevent cross-contamination (fungal skin infection) please observe the following time intervals for disinfection:

- Weighing plate before and after any measurement with direct skin contact
- When required:
 - Display
 - Touch-sensitive keyboard



Do not spray disinfectants onto appliance.

Make sure that disinfectant does not penetrate the interior of the balance.

Remove dirt immediately.

14.3 Sterilisation

Sterilisation of the appliance not allowed.

14.4 Service, maintenance

The appliance may only be opened by trained service technicians who are authorized by KERN.

Disconnect the scales from mains before opening.

14.5 Disposal

Disposal of packaging and appliance must be carried out by operator according to valid national or regional law of the location where the appliance is used.

15 Instant help

In case of an error in the program process, briefly turn off the balance and disconnect from power supply. The weighing process must then be restarted from the beginning.

Fault

Possible cause

The displayed weight does not glow.

- The balance is not switched on.
- The mains supply connection has been interrupted (mains cable not plugged in/faulty).
- Power supply interrupted.
- Rechargeable battery inserted incorrectly or empty
- No rechargeable battery inserted

The displayed weight is permanently changing

- Draught/air movement
- Table/floor vibrations
- The weighing plate is in contact with foreign bodies or is not correctly positioned.
- Electromagnetic fields / static charging (choose different location/switch off interfering device if possible)

The weighing result is obviously incorrect

- The display of the balance is not at zero
- Adjustment is no longer correct.
- Great fluctuations in temperature.
- Warm-up time was ignored.
- Electromagnetic fields / static charging (choose different location/switch off interfering device if possible)

Should other error messages occur, switch balance off and then on again. If the error message remains inform manufacturer.

Position adjustment switch and seals:

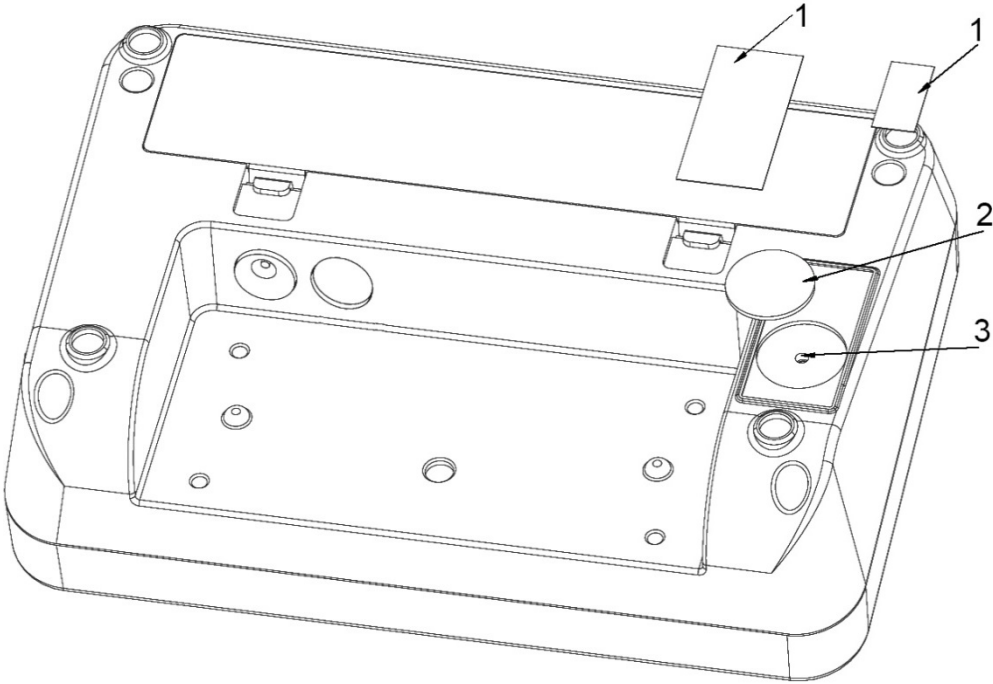







- 1. Self-destroying seal mark
- 2. Cover
- 3. Adjustment switch







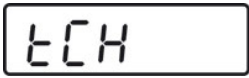







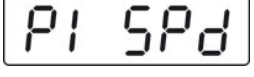

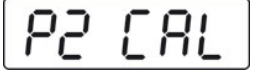

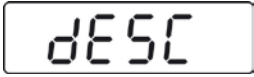
16 Adjustment



As the acceleration value due to gravity is not the same at every location on earth, each display unit with connected weighing plate must be coordinated - in compliance with the underlying physical weighing principle - to the existing acceleration due to gravity at its place of location (only if the weighing system has not already been adjusted to the location in the factory). This adjustment process must be carried out for the first commissioning, after each change of location as well as in case of fluctuating environment temperature. To receive accurate measuring values it is also recommended to adjust the display unit periodically in weighing operation.

	<ul style="list-style-type: none"> • Prepare the required adjustment weight. The adjustment weight to be applied depends on the capacity of a weighing scale, see chap. 1. Carry out adjustment as closely as possible to admissible maximum load of weighing scale. Information about test weights you will find in the internet under http://www.kern-sohn.com • Observe stable environmental conditions. For warm-up time required for stabilisation see chap. 1.
---	---

Procedure:

  	<p>⇒ In weighing mode, press  repeatedly until [tCH] appears.</p>
	<p>⇒ Press  and [Pin] will appear.</p>

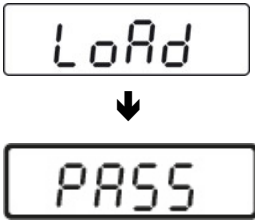
	Press  ,  and  one after the other and [P1 SPd] will appear
  	⇒ Press  , „P2 CAL“ will be displayed ⇒ Operate adjustment switch; for position see chap.17
	⇒ Press  and [dESC] will appear
	⇒ Press  repeatedly until „CAL“ will be displayed. ⇒ To confirm, press  and [UnloAd] will appear
	⇒ Ensure that there are no objects on the weighing pan. ⇒ Wait until the stability display „STABLE“ is displayed and then confirm by pressing  .
 (example)	⇒ The size of the currently set adjustment weight will be displayed. To change, select the digit to be altered by  , and the numerical value by  . ⇒ Confirm by pressing  and [LoAd] will be displayed.

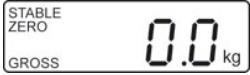
	<ul style="list-style-type: none"> ⇒ Place adjustment weight in the centre of the weighing pan ⇒ Wait until stability display „STABLE“ appears ⇒ Confirm by pressing , [PASS] will be displayed.
	<ul style="list-style-type: none"> ⇒ The balance carries out a selftest, after that [Err19] will be displayed and a signal will sound. ⇒ Switch off the balance ⇒ Take away adjustment weight ⇒ Turn on balance again, after the selftest the balance changes into the weighing mode. Adjustment has now been completed successfully.