



Sauter GmbH

Ziegelei 1
D-72336 Balingen
e-mail: info@kern-sohn.com

Phone : +49-[0]7433- 9933-0
Fax: +49-[0]7433-9933-149
Internet: www.sauter.eu

Instruction manual mobile Leeb hardness tester

SAUTER HK-D/HK-DB

Version 2.0
04/2020
GB



PROFESSIONAL MEASURING

HK-D_HK-DB-BA-e-2020



SAUTER HK-D/HK-DB

V. 2.0 04/2020

Instruction manual mobile Leeb hardness tester

Thank you for purchasing the digital Leeb hardness tester from SAUTER. We hope you will be very satisfied with the high quality of the hardness tester and its extensive functionality. For any questions, wishes and suggestions please do not hesitate to contact us.

Table of contents:

1	Before commissioning	4
2	General description	4
2.1	Special features:	4
2.2	General application and test area	4
2.3	Scope of delivery and optionally available accessories	7
2.4	Working conditions	9
3	Structural characteristics and test principle	9
3.1	Structural characteristics and test principle (device view).....	9
3.2	The LEEB test principle	11
4	Technical data	11
5	Testing	12
5.1	Preparing and checking the supplied accessories.....	12
5.2	The preparation of the surface of the test piece	12
5.3	Test procedure.....	13
6	Special Operating Instructions	15
7	Detailed test procedure description	16
7.1	Commissioning.....	16
7.2	Switching on and off	16
7.3	Testing.....	16
7.4	Menu- Structure Diagram	18
7.5	Setting the measuring conditions	19
7.6	Storage management	23
7.7	Browse stored data groups	24
7.8	System settings	25
7.9	About the software	27
7.10	Calibration / Adjustment	27
7.11	Backlit display	29
7.12	Automatic switch-off.....	29
7.13	Battery replacement	29
7.14	Connection with the data transmission cable	29
8	Error analysis & troubleshooting	30
9	Service and maintenance	30

10 Notes on transport and storage conditions 30
11 Parts subject to wear and tear, which are not covered by the scope of warranty..... 30

1 Before commissioning

Before putting the device into operation, check the delivery for any transport damage to the packaging, the plastic case and the device itself. Should this be the case, SAUTER must be contacted immediately.

Precautions

1. the complete device must not be immersed in water or exposed to rain, which could cause unforeseeable damage, the battery or the display could be destroyed
2. if the device is not used for a longer period of time, it should be stored in a dry and cool place, preferably in its original packaging. The ambient temperature should be in the range of -30°C to +80°C and relative humidity (RH) 5% to 95%.

2 General description

2.1 Special features:

- Large screen (128 x 64 LCD), which displays all functions and parameters.
- Direct indication and conversion into the hardness scales HRA, HRB, HRC, HV, HB, HS.
- The menu appears in English, the hardness tester is easy and convenient to use.
- USB interface included, multiple communication options are possible to meet the customer specific requirements of different users.
- Seven rebound sensors are available for special applications. These do not need to be recalibrated after replacement, the system has an automatic type recognition of the rebound sensors.
- Large memory capacity; can store more than 600 measurement groups (number of rebounds: 32~1) in the internal non-volatile measurement memory.
- The upper and lower limits can be preset. Automatic alarm is triggered when the measurement result exceeds the preset limit.
- The backlit display makes working even in less illuminated environments pleasant.
- It has a test result software calibration function
- The material "cast steel" has been added; the HB values can be read directly when the D/DC rebound sensor is used to measure a material sample of "cast steel".
- The power supply is provided by 2 x AA batteries.

The continuous working time is up to 200 hours with the display lighting switched off.

- The software for the PC can be installed according to the user's requirements. This function will become more and more important in view of the ever-increasing demands on quality control and management.

2.2 General application and test area

2.2.1 General application

- for assembled machine parts and permanently installed parts
- Measuring at recesses of moulded parts

- Heavy work objects
- Fault analysis of pressure boilers, steam generators and other equipment
- In a narrow, difficult to access test area where the work item is installed
- Guide bearings and other parts
- Material identification of the metal type

Fast tests on a large scale and various measuring positions for heavy work objects

2.2.2 Test area

Table 1

Material	Hardness-method	D/DC	D+15	C	G	DL
Steel and Cast steel	HRC	17.9~68.5	19.3~67.9	20.0~69.5		20.6~68.2
	HRB	59.6~99.6			47.7~99.9	37.0~99.9
	HRA	59.1~85.8				
	HB	127~651	80~638	80~683	90~646	81~646
	AGM	83~976	80~937	80~996		80~950
	HS	32.2~99.5	33.3~99.3	31.8~102.1		30.6~96.8
Hammered steel	HB	143~650				
Cold Working- Tools- steel	HRC	20.4~67.1	19.8~68.2	20.7~68.2		
	AGM	80~898	80~935	100~941		
Stainless steel	HRB	46.5~101.7				
	HB	85~655				
	AGM	85~802				

Grey cast iron	HRC				
	HB	93~334			92~326
	AGM				
Ductile Cast Iron	HRC				
	HB	131~387			127~364
	AGM				
Aluminium casting alloys	HB	19~164		23~210	32~168
	HRB	23.8~84.6		22.7~85.0	23.8~85.5
Brass (copper-Zinc alloys)	HB	40~173			
	HRB	13.5~95.3			
Bronze (Ku-Alu/ Ku-Zinc alloy)	HB	60~290			
Wrought copper alloy	HB	45~315			

Table 2

No.	Material	HLD	Strength σ_b (MPa)
1	Structural Steel	350~522	374~780
2	High carbon steel	500~710	737~1670
3	Cr Steel	500~730	707~1829
4	Cr-V Steel	500~750	704~1980
5	Cr-Ni steel	500~750	763~2007
6	Cr-Mo steel	500~738	721~1875
7	Cr-Ni-Mo steel	540~738	844~1933
8	Cr-Mn-Si steel	500~750	755~1993
9	High strength steel	630~800	1180~2652
10	Stainless steel	500~710	703~1676

2.3 Scope of delivery and optionally available accessories

	No.			Notes
Standard scope of delivery	1	Display unit	1	
	2	D-type rebound body	1	
	3	Small stabilizing ring	1	
	4	Cleaning brush	1	
	5	Screwdriver	1	
	6	Hardness test block	1	Only for HK-DB
	7	Interface cable	1	
Optional	8	Software		
	9	Various other rebound sensors		See Table 3
	10	Different types of support rings		See table 4

Table 3



Type of rebound sensor	DC(D)/DL	D+15	C	G
Rebound energy	11mJ	11mJ	2.7mJ	90mJ
Mass of the rebounding body	5.5g/7.2g	7.8g	3.0g	20.0g
Tough test tip:	1600HV	1600HV	1600HV	1600HV
Diameter hardness test tip:	3mm	3mm	3mm	5mm
Material of the hardness test tip:	Tungsten-carbide	Tungsten-carbide	Tungsten-carbide	Tungsten-carbide
Diameter rebound sensor:	20mm	20mm	20mm	30mm
Length rebound sensor:				
Weight rebound sensor:	86(147)/75mm 50g	162mm 80g	141mm 75g	254mm 250g
Max. Hardness of the pattern	940HV	940HV	1000HV	650HB
Ra:General roughness value of the Sample surface	1.6µm	1.6µm	0.4µm	6.3µm
Minimum weight of the sample:	>5kg	> 5kg	> 1.5kg	> 15kg
For direct measurement	2~5kg	2~5kg	0.5~1.5kg	5~15kg
With fixed support				
With fixed coupling	0.05~2kg	0.05~2kg	0.02~0.5kg	0.5~5kg

Min. strength d. Pattern with fixed coupling		5mm	5mm	1mm	10mm
Min. coating thickness at Surface hardening		≥0.8mm	≥0.8mm	≥0.2mm	≥1.2mm
Hardness 300HV	Penetration diameter	0.54mm	0.54mm	0.38mm	
	Penetration depth	24μm	24μm	12μm	
Hardness 600HV	Penetration diameter	0.54mm	0.54mm	0.32mm	
	Penetration depth	17μm	17μm	8μm	
Hardness 800HV	Intruder Diameter	0.35mm	0.35mm	0.35mm	
	Penetration depth	10μm	10μm	7μm	
Available types of Rebound sensors		D: General tests DC: tests holes or cylindrical cavities DL: tests slender or narrow hollows or holes	D+15: tests grooves or furrows (sinks)	C: tests small, light, thin parts and surfaces of hardened coatings	G: Tests large, thick, heavy or rough steel surfaces

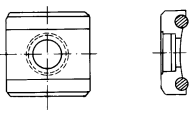
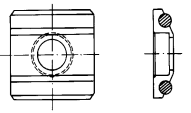
Table 4, as an option: various support rings

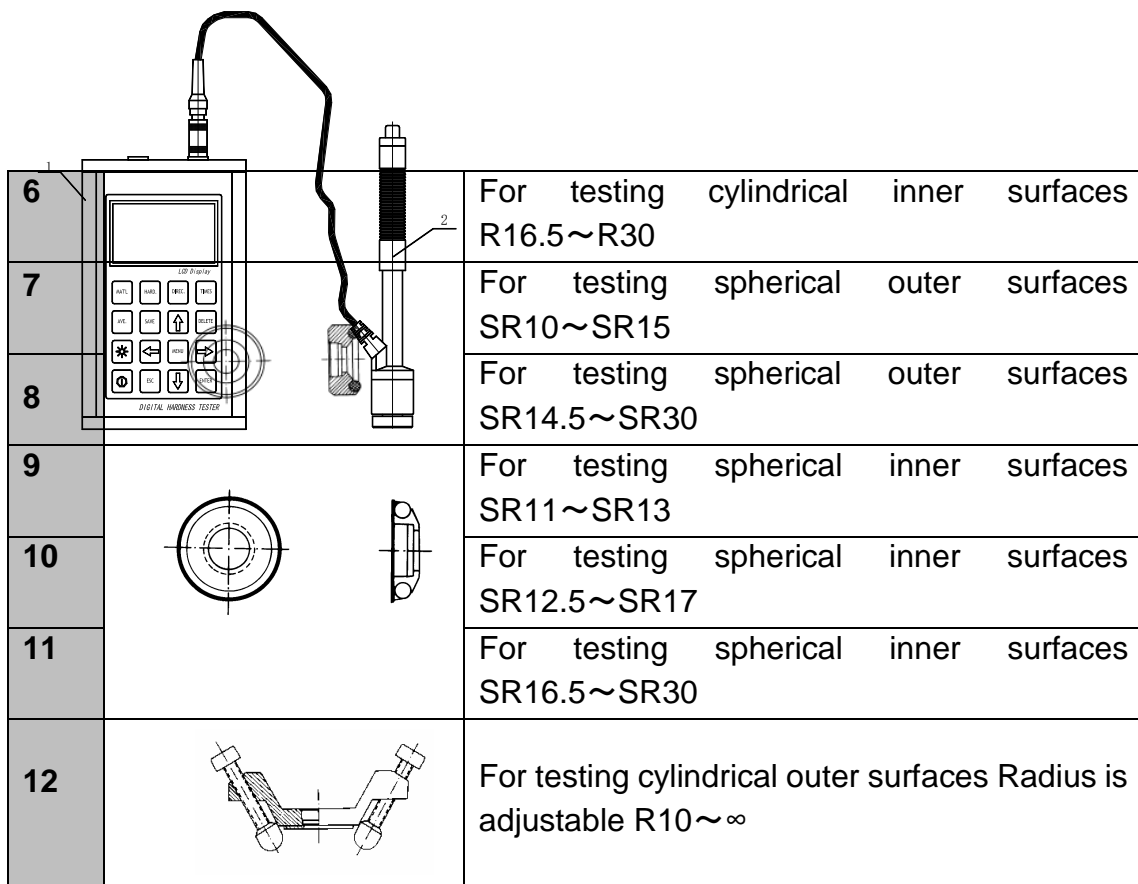
No.	Rupture of non-conventional stabilising rings	Notes
1		For testing cylindrical outer surfaces R10~R15
2		For testing cylindrical outer surfaces R14.5~R30
3		For testing cylindrical outer surfaces R25~R50
4		For testing cylindrical inner surfaces R11~R13
5		For testing cylindrical inner surfaces R12.5~R17

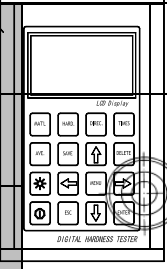
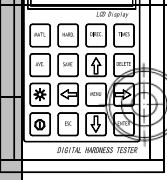
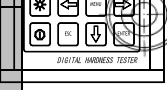
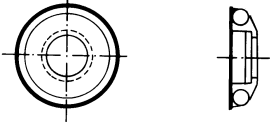

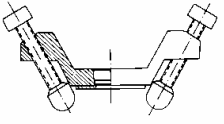
6		For testing cylindrical inner surfaces R16.5~R30
7		For testing spherical outer surfaces SR10~SR15
8		For testing spherical outer surfaces SR14.5~SR30
9		For testing spherical inner surfaces SR11~SR13
10		For testing spherical inner surfaces SR12.5~SR17
11		For testing spherical inner surfaces SR16.5~SR30
12		For testing cylindrical outer surfaces Radius is adjustable R10~∞

2.4 Working conditions

Temperatures: -10°C to +40°C

Relative air humidity: ≤ 90%

The device should not be exposed to vibrations, strong magnetic fields, corrosive agents and strong dust in the environment.

3 Structural characteristics and test principle

3.1 Structural characteristics and test principle (device view)

3.1.1 The endurance tester

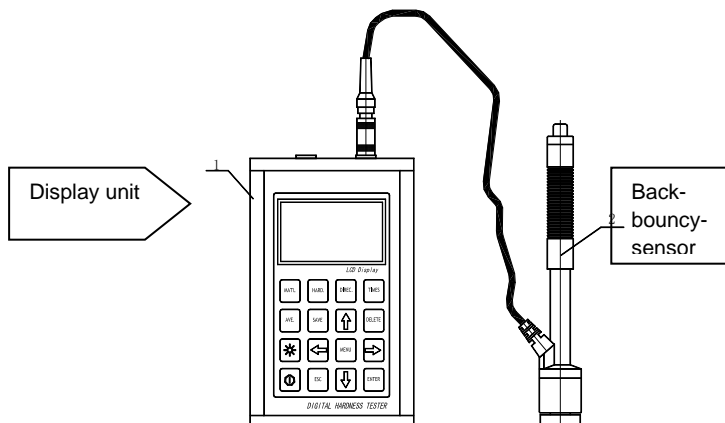

3.1.2 The display unit

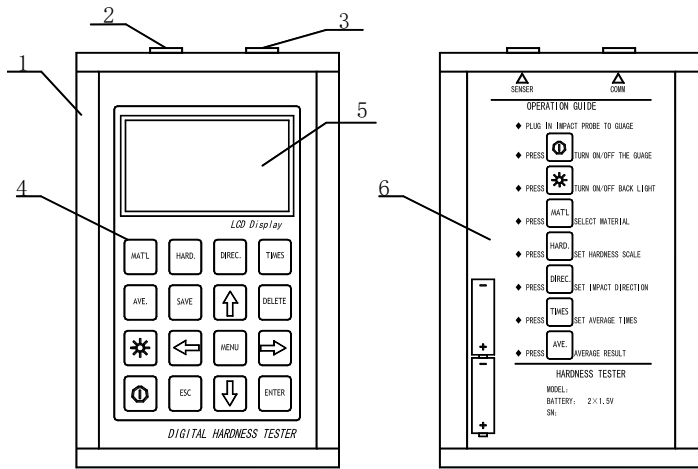

1. Housing
2. Connection for connecting cable
3. Connection for rebound sensor
4. Control buttons
5. LCD screen
6. Key description on the back of the housing

3.1.3 The D-type rebound sensor

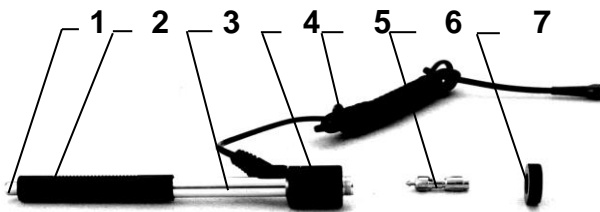

1. Release button
2. Charging Tube
3. Guide Tube
4. Coil
5. Connection cable
6. Rebounders
7. Stabilisation ring

3.1.4 Different types of rebound sensors

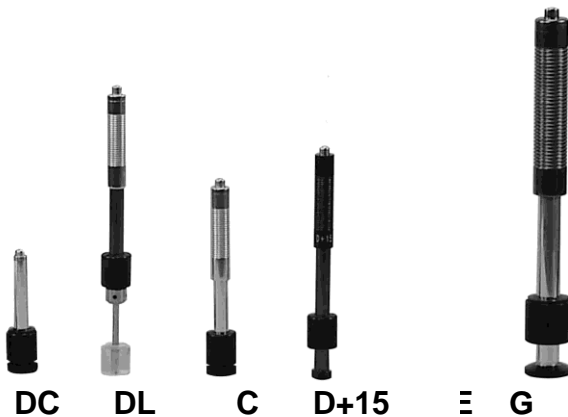

3.2 The LEEB test principle

The basic principle is to use a rebound body of a specified weight, which is impacted on the test surface using a specified test force and then the impact velocity and rebound velocity of the rebound body are measured with the spherical test tip 1mm above the surface to be tested.

The calculation formula is as follows:

$$HL = 1000 \times VB/VA$$

HL → Leeb Hardness value

VB → Impact velocity of the impactor

VA → Rebound velocity of the rebounding body

4 Technical data

- Display range: 170 to 960 HLD
- Measuring direction: all directions possible, 360
- LCD display: (128 x 64 matrix) backlit LCD
- Data memory: 48 up to 600 measuring groups (number of rebounds: 1 to 32 each)
- Measurement results can be automatically converted into: HL, HB, HRB, HRC, HRA, HV, HS
- Weight of the rebound body: 5,5 g
- diameter of the test tip: 3mm
- Material of the test tip: tungsten carbide
- Range for upper and lower limit value: the same as the measuring range (170 to 960 HLD)
- operating voltage: 2*1,5V
- Continuous working time: approx. 200 hours (without display backlighting)
- Interface connection: USB
- Accuracy and repetition frequency of the displayed value, see Table 5
- Dimensions: 132 x 82 x 33 mm (display unit)
- Weight: approx. 0.6 kg (display unit)
- Ambient temperature -30°C to +80°C

- Relative humidity (RH) 5% to 95%.

- Hardness test block of hardness 790+/- 40HL included in delivery for model HK-DB

Table 5

No	Type Rebound sensor	Hardness value v. Leeb Standard Hardness Block	ERROR Display value	Again-availability
1	D	760±30HLD 530±40HLD	±6 HLD ±10 HLD	6 HLD 10 HLD
2	DC	760±30HLDC 530±40HLDC	±6 HLDC ±10 HLDC	6 HLD 10 HLD
3	DL	878±30HLDL 736±40HLDL	±12 HLDL	12 HLDL
4	D+15	766±30HLD+15 544±40HLD+15	±12 HLD+15	12HLD+15
5	G	590±40HLG 500±40HLG	±12 HLG	12 HLG
6	C	822±30HLC 590±40HLC	±12 HLC	12 HLC

5 Testing

5.1 Preparing and checking the supplied accessories

5.2 The preparation of the surface of the test piece

The preparation of the surface of the test piece should conform to the relative requirements of Annex Table 3.

- During preparation, heating as well as cooling of the surface of the test piece should be avoided, as this can significantly affect the hardness test measurement.

- Too much roughness of the surface to be measured can lead to incorrect measurements (ERROR). Therefore, the surface of the test piece should be metallically shiny, smooth and clean and free of oil residues.

- Curved surface: The best test surface is a smooth, flat surface. If the radius of curvature R on the surface to be tested is less than 30mm (D, DC, D+15, C and DL type rebound sensors are suitable) and less than 50mm (G type is suitable), the small stabilising ring is used in the first case and the shaped stabilising ring in the second.

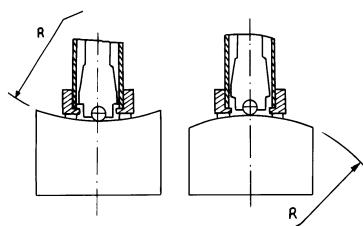

- Weighing down the test piece: this is not necessary for heavy test pieces. Medium-heavy objects are placed on a smooth and stable surface. The test piece should be placed absolutely flat and without wobbling.
- A sufficient material thickness of the test piece is required, as well as the minimum material thickness.
- As for the hardened surface coating of the test piece: the thickness of this should also meet the requirements of Table 3.
- Coupling: Very light test pieces should be firmly coupled to a heavy base plate. Both of these surfaces to be coupled must be flat and smooth and coupling agent may be left behind. The rebound direction is vertical to the coupled surface. If the sample is a large plate, long rod or bent, it may be deformed and become unstable, even though the weight and strength are sufficient, and consequently the test values will not be accurate. Therefore, the test piece should be reinforced or supported on its back.
- Magnetism of the test piece itself should be less than 30 Gauss.

5.2.1 System settings of the hardness tester

Specific procedure for the setting: see Chap.6.9

5.2.2 Setting the measurement conditions of the tester

Specific procedure for the setting: see Chap.6.5

5.3 Test procedure

The hardness tester should be checked with a standard hardness test block. The ERROR value and the repeatability of the value to be read are given in Table 5 in the Appendix.

Note: The hardness value of the standard hardness test block can be measured with a Leeb hardness tester which has been calibrated; 5 measurements should be taken vertically downwards. This should be used to calculate the arithmetic mean and this can then be taken as the hardness value of the standard test block. If the value exceeds the standard range, the instrument can be calibrated for the user using the calibration function.

5.3.1 Connection sensor to display unit

- The rebound sensor plug is inserted into the socket of the rebound sensor in the measuring instrument.
- The power button  is pressed and the unit is ready for testing.

5.3.2 Shop

- The loading tube is pushed down to lock the rebound body in place; with the DC Rebound Sensor, the load bar can be placed on the surface to be tested, then the DC Rebound Sensor is inserted into the load bar until the stop position. This completes the loading process.

Localization

The support ring of the rebound sensor is now pressed firmly onto the surface of the test piece, whereby the rebound direction should always be vertical to the surface to be tested.

5.3.3 Testing

- For testing, the release button on the upper side of the rebound sensor is pressed. It is assumed that the test piece as well as the device are in a fixed position at this time. The direction of action should pass through the axis of the rebound sensor.
- Each measuring range of the test piece normally requires 5 individual test procedures. The result of the measurement data scatter should be the general value of do not exceed $\pm 15HL$.
- The distance between two rebound points and the distance from the centre of any one rebound point to the corner of the test piece should be as prescribed in Table 6.
- A comparative test must be carried out for each specific material to obtain the corresponding conversion ratio if this Leeb hardness value is to be converted into the other hardness values.

The procedure is as follows:

Tests are performed using the Leeb hardness tester (or other equivalent hardness tester), which has been correctly recalibrated, on the same test piece.

For each hardness value 5 points should be selected for tests, which are uniformly distributed and at least 3 indentation tests should be made for each of them; this requires the conversion of the hardness value. The arithmetic mean value of the Leeb hardness and the mean value of the corresponding hardness serve as relevant values to create an individual hardness comparison curve. This curve should contain at least three groups of correlating data in the comparison curve.

Table 6

Type of rebound sensor	Distance from the centre of the two indentations	Distance from the centre of the indentation to the corner of the test piece
	Not less than(mm)	Not less than(mm)
D, DC	3	5
DL	3	5
D+15	3	5
G	4	8
C	2	4

5.3.4 Reading the measured value

5.3.5 Print measurement result

The special procedure is described in chapter 6.3.3 and 6.6

5.3.6 To switch off, press the off button

5.3.7 Evaluation of the test results

The mean value of 5 valid test points can be recorded as a test result of the Leeb hardness.

5.3.8 What the measurement result expresses

- The hardness value appears on the display above HL (the Leeb hardness symbol). The type of rebound sensor can be read to the right after the letters HL. For example, 700HLD means that the hardness is 700, measured with the rebound sensor D.

- For other hardness types into which Leeb hardness has been converted, the corresponding hardness symbol should be added before the Leeb hardness symbol. Go to

Example 400HVHLD, which states that the Vickers hardness value is 400, which was converted from the Leeb hardness value measured with the rebound sensor D.

Important note:

HL values measured with different types of rebound sensors are different.

For example: 700 HLD does not equal 700 HLC!

6 Special Operating Instructions

- The replacement of a rebound sensor must always be carried out with the system switched off, otherwise the special type of rebound sensor cannot be detected automatically afterwards. It is even possible (with the instrument switched on) to damage the base board of the hardness tester.

- Under normal conditions, the current measured value can be printed out and stored if the value der **【Anzahl of Rückpralle】** noch is not sufficient. If printing or saving is required at this point, Taste **【Average】** can be pressed to terminate the measurement. Afterwards the printout can be made.

- The functions **【Auto Save】** , **【Auto Print】** , and **【Auto Trans.】** sind inactive if the key **【Average】** betätigt has been set to terminate the measurement in advance.

- Only the type D and DC rebound sensors have the function of measuring tensile strength, so the default setting **σb】 /σb】** cannot be changed if other types of rebound sensors are used. If the presetting has been made using the D/DC rebound sensor in **【σb】** gewechselt, the setting **【Hardσb】** in **【Hard】** will be changed if another rebound sensor is installed (instead of the D or DC type).

- If **【σb】** (tensile strength) has been preset, the hardness scale cannot be set (the cursor skips it).

- Not all materials can be converted to every hardness scale, the hardness scale automatically returns to Leeb hardness (HL) as soon as the material has been changed. It must be entered **【Material】** vorab when the measuring parameters are preset and only then the hardness scale **【Hardness Scale】** .

7 Detailed test procedure description

7.1 Commissioning

⓪ Press the key to switch on the hardness tester. The following is shown:

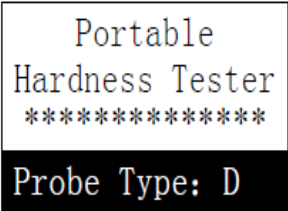

The tester checks the rebound sensor in use and shows it on the display. At this point it should be carefully checked that it is correctly displayed, after which the main display is shown.

7.2 Switching on and off

The measuring instrument can be switched on or off ⓪ in any display status by pressing the button.

7.3 Testing

The hardness tester enters the main display after switching on. The following can be seen:

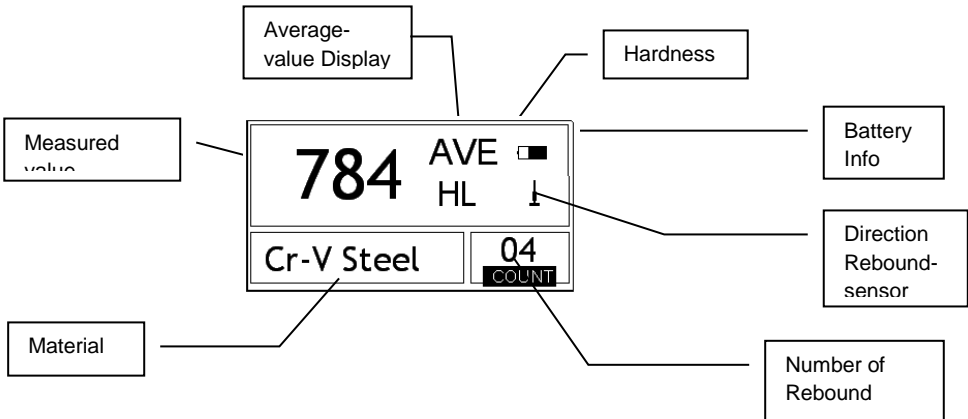

The measurement result is shown in large letters on this display, as are several other operating functions.

7.3.1 Instructions for the display Main display

Battery Info: The remaining capacity of the battery when not charging is displayed. When the battery is charging, the charge level is displayed.

Rebound sensor direction: The current direction of the rebound sensor is displayed

Average value display: The average value of the test pieces is displayed as soon as the preset rebound number is reached.

Rebound direction: the current rebound orientation is displayed

Hardness scale: Hardness scale of the current measured value

Measured value: The current measured value in single measurement mode is displayed (without average measured value display), or the current average value is displayed. ↑ means the value is above the conversion value or measuring range. ↓ bedeutet, it is below.

Material: Displays the current preset material.

Number of rebounds: Shows the number of rebounds performed individually. The number of pre-set rebounds appears on the display as soon as it has been entered using the shortcut key. The number of rebounds associated with the individually measured value is shown on the display.

7.3.2 Procedure for testing

Measurements can now be carried out under this connection status and the current measured value is displayed as soon as a measurement has been completed. The digit of the rebound counter increases by one with each rebound individually performed.

The buzzer leaves a long beep if the value is not within the tolerance limit. When the preset number of rebounds has been reached, two short beeps will sound. After 2 seconds a short signal tone sounds and the average value is displayed.

7.3.3 Key function

- Use the key **【SAVE】** wird to store the current measuring group in the memory. This operation can only be carried out after the average value has appeared on the display. In addition, this memory function can also be executed only once.

- With the key **【DEL】** wird the last single value is deleted. When this key is pressed, the following appears on the display:

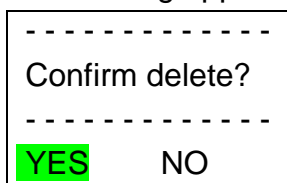

- Pressing or **◀** key will move **▶** the cursor to nach **【YES】** bewegt. Use the key **【ENTER】** wird to confirm the deletion of the last individual measured value.

- Press the or **▶** key to move the cursor to nach **【NO】** bewegt. Pressing the key **【ENTER】** wird cancels the deletion. Deleting can also be cancelled by pressing **【ESC】** abgebrochen wherever the cursor is located.

- Use the keys 【▲】 und 【▼】 wird to display the individual measured value. The average value or the last measured value can be displayed again by pressing the 【ESC】 aufzeigt key. The viewing sequence varies depending on the 【▲▼】 oder key.
- Press the key 【AVG】 kann to end the test, even if the preset rebound number has not yet been reached, and the average value calculated from this is displayed.
- Use the key 【☼】 wird to switch the LCD backlight on or off.
- Press the key 【MENU】 oder 【ENTER】 gelangt to enter the main menu of the system.

Preset of the shortcut keys:

- Use the 【DIREC】 wird key to set the direction of the rebound sensor.
- Use the key 【TIMES】 wird to change the number of rebounds in a measuring group. The current number of rebounds can be changed by first pressing the key 【TIMES】 angezeigt. Each time the Taste 【TIMES】 erhöht key is pressed again, the number of rebounds increases by plus one. The value jumps back to 1 when the number of rebounds reaches 32.
- Change the hardness scale with the key 【HARD】 wird. Whenever this button is pressed, a continuous conversion takes place under all existing hardness scales which are available for the material currently under test and the corresponding rebound sensor. The hardness scale is converted to Leeb hardness if the current default setting is "Tensile strength measurement".
- Use the key 【MAT'L】 kann to select another material. Whenever this button is pressed, a continuous conversion is made under all existing material settings. The hardness scale is converted to Leeb hardness. Therefore, the material should be entered first before measuring, and then the hardness scale is set.

Note: What is referred to here as "reevaluation" refers to the corresponding relationship of Leeb hardness and other hardnesses for a particular material, which has been established on the basis of extensive testing. According to the conversion relationship, the value measured in Leeb hardness is automatically converted into other hardness scale values by means of the converter located in the hardness tester.

7.4 Menu- Structure Diagram

Both the presetting of parameters and the additional functions are controlled via the menu. On the main display, press the 【MENU】 betätigt key to enter the main menu:

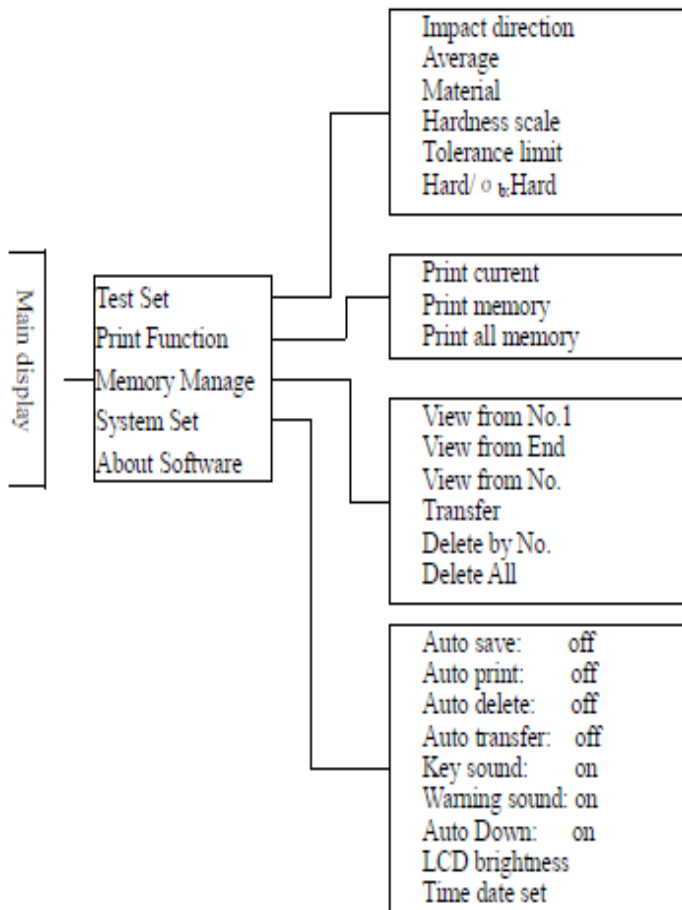

7.5 Setting the measuring conditions

On the main display of the screen, the Taste **【MENU】** betätigt to enter the main menu.

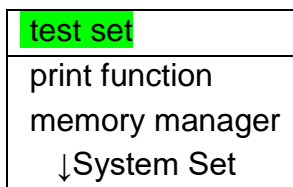

Press the key **【ENTER】** wird to enter the submenu **【TEST Set】** zu. Using the keys **【▲】** und **【▼】** wird moves the cursor to the desired position and then **【ENTER】** gedrückt.

Note: 1. if **【Hard6b】** is set to **【Hard】**, the hardness scale obviously could not be selected. The cursor automatically jumps over **【Hardness】** when it is moved.
 2. only the D and DC types of rebound sensors have the tensile strength measurement function. Therefore, the cursor cannot be used to select the function **【Hard /6b】** for other rebound sensors.

```
Impact Direc.
Average
Material
Hardness Scale
Tolerance Limit
Hard/σ b: Hard
```

3. the arrow symbol ↓ on the lower left side of the menu and indicates that the menu does not end yet and further submenus follow downwards These can be changed to] aufgezeigt by pressing ▼ [. ▼ The symbol ↑ on the upper side of the menu and indicates that the menu does not end yet and further submenus follow at the top. These can become ▲] aufgerufen with the [key.

7.5.1 Direction adjustment of the rebound sensor

```
Impact Direction
=====
█ ◀ ▶ ▸ ⏪ ⏩
```

Use the keys [◀ ▶] oder [] wird to move the cursor to the desired preset of the rebound sensor.

Confirm with the key [ENTER] wird.

With the Taste [ESC] kann can be canceled.

7.5.2 Setting the average time

```
Mean Times
=====
  03
```

Average times can be changed in the range of 1~32. The value is entered with the corresponding number key. The cursor automatically moves to the next number as you enter it. Press the key [ENTER to confirm] wird.

Press the [ESC button to cancel] kann.

7.5.3 Material adjustment

The following available materials can be shown if **【Hard6b】** is preset to **【Hard】** :

(Cast Steel)
CWT. Steel
STAIN. Steel
GC. Iron
NC. Iron
Cast Alumin
Copper- Zinc
Copper- Alumin
Wrought Copper

Use the keys **【▼】** und **【▲】** wird to move the cursor to the desired material to be preset. Confirm with the key **【ENTER】** wird.

Press the **【ESC button to cancel】** kann.

Note:1 After changing the material preset, the hardness scale setting automatically returns to the LEEB hardness HL.

2. it is therefore recommended to select the material first, then the hardness scale.

3. the arrow symbol **↓** on the lower left side of the menu and indicates that the menu does not end yet It can be scrolled down using the **▼【▼】** key. The symbol **↑** on the upper side of the menu indicates that the menu does not end yet. It can be scrolled up using the **【▲】** nach key.

The following available materials can be shown if **6b】/6b】** is preset to **【6b】** :

Mild Steel
High- C Steel
Cr Steel
Cr-V Steel
Cr-Ni Steel
Cr-Mo Steel
Cr-Ni- MoSteel
Cr-Mn- Si Steel
Super ST. Steel
STAIN. Steel

Use the keys **【▼】** und **【▲】** wird to move the cursor to the desired material to be preset.

Confirm with the key **【ENTER】** wird.

Press the **【ESC button to cancel】** kann.

Note: The arrow symbol **↓** on the lower left side of the menu and indicates that the menu does not end yet. It can be scrolled down using the **▼【▼】** key. The symbol **↑** on the upper side of the menu indicates that the menu does not end yet. It can be scrolled up using the **【▲】** nach key.

7.5.4 Setting Hardness scale

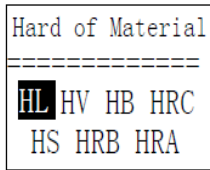

Use the keys 【←】 und 【→】 wurd to move ▶the cursor to the desired hardness scale. Confirm this change with the key 【ENTER】 wurd.

Press the 【ESC button to cancel】 kann.

Note: 1. only the valid hardness scale for the currently selected rebound sensor and material is shown here. The other hardness scales are not shown.

2. it is recommended to select the material first, then the hardness scale.

3. the hardness scale setting automatically returns to HL once the material has been changed and confirmed

7.5.5 Setting tolerance limit

Enter the number with the keys 【0】 ~ 【9】 wurd

The cursor automatically slides to the next number. Confirm with the key 【ENTER】 wurd.

Press the 【ESC button to cancel】 kann.

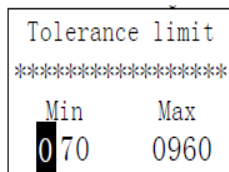

Note:1 If the specified value exceeds the measuring range, the hardness tester reminds you to set it again.

2. if the lower limit is greater than the upper limit, these are automatically exchanged

7.5.6 Hardness/ Strength (σ_b) Default setting

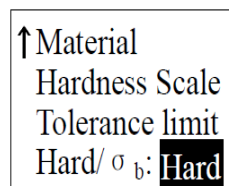

Use the key 【ENTER】 wurd to switch between zwischen 【Hard/σ_b】 and the cursor to switch between hardness and strength.

Note: Only type D and DC of the rebound sensors have the strength measurement. So

【Hard】 is the only choice if the rebound sensor is not a D type or DC type.

7.5.7 Print out all stored measurement data

By pressing 【Print All Mem】 können all measured values of all measuring groups of the memory are printed out in the same way.

7.6 Storage management

On the main display, the key 【MENU】 betätigt to enter the main menu.

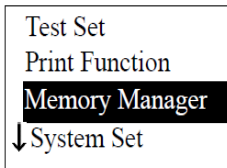

Use the keys 【▼】 und 【▲】 wird to move the cursor to 【Memory Manager】 bewegt.

With the button 【ENTER】 gelangt you can go to 【Memory Manager】 Menu.

If there is no data in memory, < No Memory! > appears on the display and you return to the main menu.

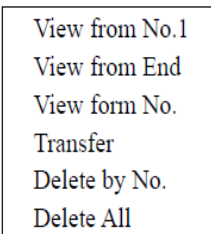

Use the keys 【▼】 und 【▲】 wird to move the cursor to the desired function and then use the key 【ENTER】 to select】 bestätigt.

7.6.1 View from No.1 measuring group/ View from the last measuring group

At 【View From No.1】 werden the values from the first measuring group on are shown in the memory.

At 【View From End】 werden the values from the last measuring group on are shown in the memory.

7.6.2 View from the selected measuring group no.

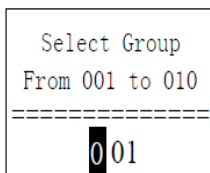

Go to 【View From No.】 und and the item to be selected is shown.

Use the number key to enter the desired value.

Press 【ENTER】 werden to call up the memory data from the selected initial group.

Press the key 【ESC】 wird to cancel the process.

7.6.3 Deleting a selected measuring group

```
Select Group
(001 to 010)
=====
From 001 to 001
```

With the Funktion **【Delete by No. 】** wird the number of measuring groups to be deleted is selected.

Use the number key to enter the number.

The selected measuring group is deleted with Taste **【ENTER】** wird.

Press the key **【ESC 】** wird to cancel the process.

Note: 1 If the preset number of measuring groups exceeds the current offer, the current measuring groups between them are deleted.

2. there is no difference in the sequence of deleting whether the deletion is carried out from the first or the last measuring group, the sequence 1 to 5 or 5 to 1 can be entered.

3. the measuring group stored in the memory is reassigned after deletion.

4. if measurement data are deleted, especially small measurement groups, because the following measurement data are to be moved up, this takes a maximum of 30 seconds.

While data is being deleted, the device must not be switched off. This can confuse all measurement data!

7.6.4 Delete All

The function **【Delete All 】** werden deletes all existing data in memory.

7.6.5 Deletion confirmation

```
=====
Confirm Delete?
=====
YES NO
```

Use the keys **【◀】** und **【▶】** wird to move ▶the cursor to

【YES】 bewegt and confirm the deletion process with the key **【ENTER】** wird.

Use the keys **【◀】** und **【▶】** wird to move ▶the cursor to

【NO】 bewegt and with the key **【ENTER】** wird the deletion process is aborted.

7.7 Browse stored data groups

```
No. 001 02/07 62.4HSD
No. 002 03/07 77.6HSD
No. 003 03/07 546HL
No. 004 03/07 483HL
No. 005 04/07 666HL
No. 006 06/07 787HL
No. 007 06/07 690HL
No. 008 08/07 820HL
```

Up to eight measurement groups can be displayed simultaneously with number, date and average value per measurement group.

Use the keys 【▼】 und 【▲】 wird to display the previous or next page.

Press the key 【ESC】 wird to cancel the process.

To move the cursor to the desired line in which the details are to be viewed, first press the key 【ENTER】 gedrückt.

Use the Tasten 【▼】 und 【▲】 wird buttons on the corresponding page to select the desired group.

With 【ESC】 gelangt you go to the previous page.

Use the key 【ENTER】 können to display details in this group.

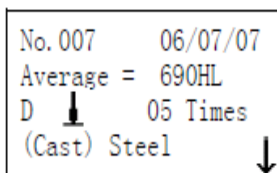

```
No. 007    06/07/07
Average = 690HL
D ↓      05 Times
(Cast) Steel ↓
```

Use the keys 【▼】 und 【▲】 kann to scroll from page to page to view the average value, test settings or individual value.

The 【ESC】 Taste returns to the previous page.

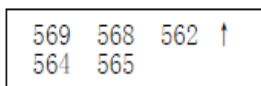

```
569 568 562 ↑
564 565
```

7.8 System settings

From the main display on the screen, press 【ESC】 gedrückt to go to the main menu.

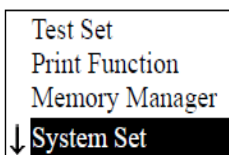

```
Test Set
Print Function
Memory Manager
↓ System Set
```

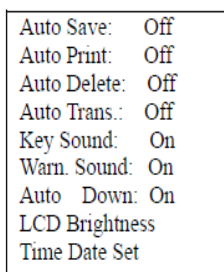

```
Auto Save: Off
Auto Print: Off
Auto Delete: Off
Auto Trans.: Off
Key Sound: On
Warn. Sound: On
Auto Down: On
LCD Brightness
Time Date Set
```

Use the keys 【▼】 und 【▲】 wird to move the cursor to Position 【System Set】 gebracht.

With the button 【ENTER】 wird the Menu 【System set】 betreten.

Use the keys 【▼】 und 【▲】 wird to move the cursor to the desired position. Use the 【ENTER】 wird key to change the setting directly or to change it yourself on the corresponding screen page.

With the key 【ESC】 gelangt you go back.

The functions 【Auto Save】 , 【Auto Delete】 , 【Auto Trans】 , 【Key Sound】 , 【Warn Sound】 können on 【ON】 oder 【OFF】 gesetzt are used.

If the function 【Auto Save】 auf became 【ON】 gestellt, the current measurement group can be saved automatically after the measurement after the average value has been displayed.

If the function 【Auto Delete】 auf 【ON】 gestellt has been set, gross measurement errors are automatically deleted as soon as the number for the average measurements has been reached or the measurement has been ended in advance with the 【AVE】 key (according to the rule ³⁶).

If data has been deleted, additional measurements are required to reach the preset times.

If the function is 【Auto Trans】 auf 【ON】 gestellt, the value of the current measuring group can be transmitted via RS 232 (after measurement and after the average value has been displayed).

If the function is 【Key Sound】 auf 【ON】 gestellt, the buzzer will sound a short horn each time the button is pressed.

If the function is 【Warn Sound】 auf 【ON】 gestellt, the buzzer emits a long honking sound each time the measured value exceeds the tolerance limit, has reached the preset average times or number of erased data.

If the function is 【Auto Down】 auf 【ON】 gestellt, the instrument switches off if no key is pressed or a measurement is taken within 5 minutes.

7.8.1 LCD brightness control

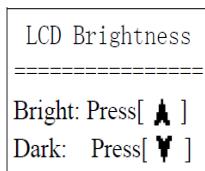

To increase the brightness, press the 【▲】 button, to decrease it, press the 【▼】 betätigt button.

Confirm with the key 【ENTER】 wird.

Press the 【ESC button to cancel】 kann.

7.8.2 Time and date setting

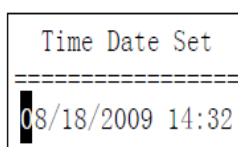

This page shows the current time and date in the following format: "mm/dd/yy". (month, day, year).

Use the keys 【▼】 und 【▲】 wird to enter the desired number and use the keys 【◀】 und 【▶】 wird to ▶move the cursor.

Confirm the entries of the current time and date with the key **【ENTER】** werden.
Press the **【ESC】** kann key to cancel this process.

7.9 About the software

In the main menu the key **【MENU】** betätigt is used to get to the selection menu.

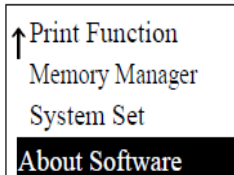

Use the keys **【▼】** und **【▲】** wird to move the cursor to **【About Software】** bewegt.
Press the **【ENTER】** wird key to go to **【About Software】** zu.

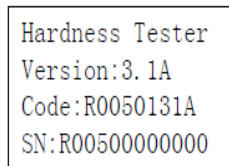

Here the user receives information about the hardness tester and its software on the screen.

However, the software version and the built-in software identification can change continuously, as they are subject to the continuous improvement process (upgrading) of the device.

7.10 Calibration / Adjustment

The hardness tester as well as the rebound sensor must be calibrated using the Leeb hardness calibration block before first use. This is included with the HK-DB, but not with the HK-D. It can also be purchased as an option. The hardness tester must also be calibrated if the device has not been used for a long period of time. It is sufficient to calibrate each individual rebound sensor once in conjunction with the display unit; recalibration is no longer necessary after a rebound sensor has been replaced.

The key **【⊙】** und is pressed simultaneously with the key **【ENTER】** to enter the system. The Calibration software screen appears:

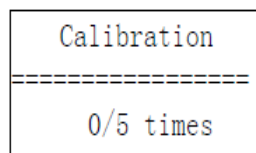

The position of the rebound sensor should be **【↓】** sein.

5 points are measured in vertical direction on the Leeb hardness calibration block.

Calibration
=====
Average=550
Nominal=550

The average value is shown after these measurements.

Use the keys 【▼】 und 【▲】 wird to enter the nominal value.

Confirm this step with the key 【ENTER】 wird.

Press the 【ESC button to cancel 】 kann. Adjustment range: $\pm 15HL$.

7.11 Backlit display

With the help of the backlit display it is possible to work even under poor lighting conditions. With the key 【*】 kann this can be switched on/off at any time after the hardness tester has been switched on.

7.12 Automatic switch-off

- This Leeb hardness tester has an automatic switch-off function to save energy. The system switches off automatically if there is no measurement or key operation within 5 minutes. However, before this automatic switch-off is activated, a flickering display signals this for 20 seconds.

This process can be interrupted at any time, with any key, except the 【Ⓢ】 Taste, thus preventing the automatic shutdown.

-If the power supply is no longer guaranteed, the display shows 【Battery Empty!】 und the instrument switches off automatically.

7.13 Battery replacement

When the battery capacity is exhausted, this symbol appears:  which flashes constantly. The batteries should then be changed according to the following procedure:

- * The hardness tester must be switched off
- * Open the screw of the battery compartment using the screwdriver provided and remove the batteries.
- * The new batteries are inserted correctly one after the other, observing the polarity.
- * The battery cover is screwed back on and the hardness tester is switched on to check whether the replacement of the batteries was successful.

7.14 Connection with the data transmission cable

Via USB cable

8 Error analysis & troubleshooting

Occurred error	Error analysis	Troubleshooting
Device cannot be switched on	Batteries exhausted	Replace batteries
	Batteries are inserted upside down, positive / negative pole	Insert batteries the right way round
No measured value visible	No connection with sensor cable	Sensor cable defective, replace
Measured value too inaccurate	Calibration data was lost	Recalibrate

9 Service and maintenance

1. Maintenance of the rebound sensors

After the rebound sensor has been used approximately 1000 to 2000 times, the nylon brush should be used to clean the guide tube and rebound body. When cleaning the guide tube, first unscrew the stabilizing ring, then remove the rebound body, turn the nylon brush clockwise to the bottom of the guide tube and pull it out again. This is repeated 5 times, after which the rebound body is reinserted and the stabilizing ring is screwed back on.

- The rebound device should be released (unlocked) after use.
- Any kind of liquid inside the rebound body is strictly prohibited.

2. Simple maintenance measures

If the Rockwell hardness test block is used for testing and the error factor is greater than 2 HRC, this may be due to the worn tip of the rebound sensor. Consideration should be given to replacing this spherical tip.

If any other abnormal phenomena occur with the test unit, do not unscrew or modify any of the permanently installed parts yourself. The device should be sent to us by telephone so that it can be checked by our service department.

10 Notes on transport and storage conditions

- The device should be kept free of vibrations, magnetic fields, corrosive agents, moisture and dust. The device should be stored at normal ambient temperature.

11 Parts subject to wear and tear, which are not covered by the scope of warranty

- Sheathing of the display unit

- Control buttons
- Rebound sensor
- Stabilisation ring
- Rebound sensor cable
- Mini USB data transfer cable
- Batteries

Note:

To view the CE declaration, please click on the following link:

<https://www.kern-sohn.com/shop/de/DOWNLOADS/>