

LCD Monitor

Instructions for Use

Before operating the unit, please read this manual thoroughly and retain it for future reference.

LMD-1530MD

HDMI™
HIGH-DEFINITION MULTIMEDIA INTERFACE



Indications for Use/Intended Use

The Sony LMD-1530MD LCD Monitor is intended to provide 2D color video displays of images from surgical endoscopic/laparoscopic camera systems and other compatible medical imaging systems. The LMD-1530MD monitor is for real-time use during minimally invasive surgical procedures and is suitable for use in hospital operating rooms, surgical centers, clinics, doctors' offices and similar medical environments.

Notes

- This equipment is for medical professionals.
- This equipment is intended for use in medical environments, such as clinics, examination rooms, and operating rooms.

WARNING

To reduce the risk of fire or electric shock, do not expose this equipment to rain or moisture.

To avoid electrical shock, do not open the cabinet. Refer servicing to qualified personnel only.

No modification of this equipment is allowed.

WARNING

To avoid the risk of electric shock, this equipment must only be connected to a supply mains with protective earth.

WARNING

This unit has no power switch.

To disconnect the main power, unplug the power plug. When installing the unit, incorporate a readily accessible disconnect device in the fixed wiring, or connect the power plug to an easily accessible socket-outlet near the unit.

Do not position the ME equipment where it is difficult to unplug the power plug.

If a fault should occur during operation of the unit, operate the disconnect device to switch the power supply off, or disconnect the power plug.

Symbols on the product



Consult the instructions for use

Follow the directions in the instructions for use for parts of the unit on which this symbol appears.



This symbol indicates the manufacturer, and appears next to the manufacturer's name and address.



This symbol indicates the EU Importer, and appears next to the EU Importer's name and address.



This symbol indicates the European Community representative, and appears next to the European Community representative's name and address.



This symbol indicates the medical device in the European Community.



This symbol indicates the date of manufacture.



This symbol indicates the serial number.



This symbol indicates the version of the accompanying document.



This symbol indicates the Unique Device Identifier (UDI), and appears next to the bar code representation of the Unique Device Identification.



This symbol indicates the equipotential terminal which brings the various parts of a system to the same potential.



Storage and transport temperature

This symbol indicates the acceptable temperature range for storage and transport environments.



Storage and transport humidity

This symbol indicates the acceptable humidity range for storage and transport environments.



Storage and transport pressure

This symbol indicates the acceptable atmospheric pressure range for storage and transport environments.

For customers in the U.S.A.

This equipment has been tested and found to comply with the limits for a Class A digital device, pursuant to part 15 of the FCC Rules. These limits are designed to provide reasonable protection against harmful interference when the equipment is operated in a commercial environment. This equipment generates, uses and can radiate radio frequency energy and, if not installed and used in accordance with the instruction manual, may cause harmful interference to radio communications. Operation of this equipment in a residential area is likely to cause harmful interference in which case the user will be required to correct the interference at his own expense.

You are cautioned that any changes or modifications not expressly approved in this manual could void your authority to operate this equipment.

All interface cables used to connect peripherals must be shielded in order to comply with the limits for a digital device pursuant to Subpart B of part 15 of FCC Rules.

For customers in the U.S.A.

Caution

Federal law (United States of America) restricts this device to sale by or on the order of a licensed healthcare practitioner.

Rx
ONLY

For customers in Canada

This unit has been certified according to Standard CAN/CSA-C22.2 No. 60601-1.

Important safeguards and notices for use in the medical environments

1. All devices connected to the unit must be certified or compliant according to IEC 60601-1, IEC 60950-1, and IEC 60065 standards and other IEC/ISO standards applicable to the devices.
2. Furthermore, the system as a whole must comply with IEC 60601-1 standards. All peripheral devices connected to the signal input/output sections of the unit constitute the medical-use system, and therefore, the user is responsible for ensuring that the system as a whole complies with IEC 60601-1 standards. If in doubt, consult qualified Sony service personnel.
3. Connecting the unit to other devices may increase the leakage current.
4. For all peripheral devices connected to the unit that operate on commercial power supplies and do not

comply with IEC 60601-1 standards, incorporate an isolation transformer that complies with IEC 60601-1 standards and connect to the commercial power supply via the transformer.

5. The unit generates, uses, and may radiate radio frequency energy. If it is not installed and used in accordance with the instruction manual, it may cause interference on other devices. If the unit causes interference (which can be determined by disconnecting the power cord from the unit), try the following.
 - Relocate the unit with respect to the affected devices.
 - Connect the unit and the affected devices to different branch circuits.

For more information, consult qualified Sony service personnel.

(Applicable standard: IEC 60601-1-2)

Important EMC notices for use in medical environments

- The LMD-1530MD needs special precautions regarding EMC and needs to be installed and put into service according to the EMC information provided in the instructions for use.
- The LMD-1530MD is intended for use in a professional healthcare facility environment.
- Portable and mobile RF communications equipment, such as cellular phones, can affect the LMD-1530MD.

Warning

- Portable RF communications equipment should be used no closer than 30 cm (12 inches) to any part of the LMD-1530MD. Otherwise, degradation of the performance of this equipment could result.
- If the LMD-1530MD will be used adjacent to or stacked with other equipment, normal operation of the LMD-1530MD under such configurations should be verified via observation.
- The use of accessories and cables other than those specified, with the exception of replacement parts sold by Sony Corporation, may result in increased emissions or decreased immunity of the LMD-1530MD.

Guidance and manufacturer's declaration – electromagnetic emissions		
The LMD-1530MD is intended for use in the electromagnetic environment specified below. The customer or the user of the LMD-1530MD should assure that it is used in such an environment.		
Emission test	Compliance	Electromagnetic environment – guidance
RF emissions CISPR 11	Group 1	The LMD-1530MD uses RF energy only for its internal function. Therefore, its RF emissions are very low and are not likely to cause any interference in nearby electronic equipment. The LMD-1530MD is suitable for use in all establishments, including domestic establishments and those directly connected to the public low-voltage power supply network that supplies buildings used for domestic purposes.
RF emissions CISPR 11	Class B	
Harmonic emissions IEC 61000-3-2	Class D	
Voltage fluctuations/ flicker emissions IEC 61000-3-3	Complies	

Guidance and manufacturer's declaration – electromagnetic immunity

The LMD-1530MD is intended for use in the electromagnetic environment specified below. The customer or the user of the LMD-1530MD should assure that it is used in such an environment.

Immunity test	IEC 60601 test level	Compliance level	Electromagnetic environment – guidance
Electrostatic discharge (ESD) IEC 61000-4-2	±8 kV contact ±15 kV air	±8 kV contact ±15 kV air	Floors should be wood, concrete or ceramic tile. If floors are covered with synthetic material, a relative humidity of at least 30% is recommended.
Electrical fast transient/burst IEC 61000-4-4	±2 kV for power supply lines ±1 kV for input/output lines	±2 kV for power supply lines ±1 kV for input/output lines	Mains power quality should be that of a typical commercial or hospital environment.
Surge IEC 61000-4-5	±1 kV line(s) to line(s) ±2 kV line(s) to earth	±1 kV differential mode ±2 kV common mode	Mains power quality should be that of a typical commercial or hospital environment.
Voltage dips, short interruptions and voltage variations on power supply input lines IEC 61000-4-11	0% U_T (100% dip in U_T) for 0.5/1 cycles ^a 40% U_T (60% dip in U_T) for 5 cycles 70% U_T (30% dip in U_T) for 25/30 cycles ^a (for 0.5 sec) 0% U_T (100% dip in U_T) for 250/300 cycles ^a (for 5 sec)	0% U_T (100% dip in U_T) for 0.5/1 cycles ^a 40% U_T (60% dip in U_T) for 5 cycles 70% U_T (30% dip in U_T) for 25/30 cycles ^a (for 0.5 sec) 0% U_T (100% dip in U_T) for 250/300 cycles ^a (for 5 sec)	Mains power quality should be that of a typical commercial or hospital environment. If the user of the LMD-1530MD requires continued operation during power mains interruptions, it is recommended that the LMD-1530MD be powered from an uninterruptible power supply or a battery.
Power frequency (50/60 Hz) magnetic field IEC 61000-4-8	30 A/m	30 A/m	Power frequency magnetic fields should be at levels characteristic of a typical location in a typical commercial or hospital environment.

NOTE: U_T is the a.c. mains voltage prior to application of the test level.

^a For example, 10/12 means 10 cycles at 50 Hz or 12 cycles at 60 Hz.

Guidance and manufacturer's declaration – electromagnetic immunity

The LMD-1530MD is intended for use in the electromagnetic environment specified below. The customer or the user of the LMD-1530MD should assure that it is used in such an environment.

Immunity test	IEC 60601 test level	Compliance level	Electromagnetic environment – guidance
Conducted RF IEC 61000-4-6	3 Vrms 150 kHz to 80 MHz outside ISM bands ^c	3 Vrms	Portable and mobile RF communications equipment should be used no closer to any part of the LMD-1530MD, including cables, than the recommended separation distance calculated from the equation appliance to the frequency of the transmitter. Recommended separation distance $d = 1.2 \sqrt{P}$
	6 Vrms 150 kHz to 80 MHz in ISM bands ^c	6 Vrms	
Radiated RF IEC 61000-4-3	3 V/m	3 V/m	IEC 60601-1-2: 2007 $d = 1.2 \sqrt{P}$ 80 MHz to 800 MHz $d = 2.3 \sqrt{P}$ 800 MHz to 2.5 GHz IEC 60601-1-2: 2014 $d = 2.0 \sqrt{P}$ 80 MHz to 2.7 GHz Where P is the maximum output power rating of the transmitter in watts (W) according to the transmitter manufacturer and d is the recommended separation distance in meters (m). Field strengths from fixed RF transmitters, as determined by an electromagnetic site survey, ^a should be less than the compliance level in each frequency range. ^b Interference may occur in the vicinity of equipment marked with following symbol: 
	80 MHz to 2.7 GHz		

NOTE 1: At 80 MHz and 800 MHz, the higher frequency range applies.

NOTE 2: These guidelines may not apply in all situations. Electromagnetic propagation is affected by absorption and reflection from structures, objects and people.

- a Field strengths from fixed transmitters, such as base stations for radio (cellular/cordless) telephones and land mobile radios, amateur radio, AM and FM radio broadcast and TV broadcast cannot be predicted theoretically with accuracy. To assess the electromagnetic environment due to fixed RF transmitters, an electromagnetic site survey should be considered. If the measured field strength in the location in which the LMD-1530MD is used exceeds the applicable RF compliance level above, the LMD-1530MD should be observed to verify normal operation. If abnormal performance is observed, additional measures may be necessary, such as reorienting or relocating the LMD-1530MD.
- b Over the frequency range 150 kHz to 80 MHz, field strengths should be less than 3 V/m.
- c The ISM (industrial, scientific and medical) bands between 150 kHz and 80 MHz are 6.765 MHz to 6.795 MHz; 13.553 MHz to 13.567 MHz; 26.957 MHz to 27.283 MHz; and 40.66 MHz to 40.70 MHz.

Recommended separation distances between portable and mobile RF communications equipment and the LMD-1530MD

The LMD-1530MD is intended for use in an electromagnetic environment in which radiated RF disturbances are controlled. The customer or the user of the LMD-1530MD can help prevent electromagnetic interference by maintaining a minimum distance between portable and mobile RF communications equipment (transmitters) and the LMD-1530MD as recommended below, according to the maximum output power of the communications equipment.

Rated maximum output power of transmitter W	Separation distance according to frequency of transmitter m				
	IEC 60601-1-2 : 2007			IEC 60601-1-2 : 2014	
	150 kHz to 80 MHz $d = 1.2 \sqrt{P}$	80 MHz to 800 MHz $d = 1.2 \sqrt{P}$	800 MHz to 2.5 GHz $d = 2.3 \sqrt{P}$	150 kHz to 80 MHz $d = 1.2 \sqrt{P}$	80 MHz to 2.7 GHz $d = 2.0 \sqrt{P}$
0.01	0.12	0.12	0.23	0.12	0.20
0.1	0.38	0.38	0.73	0.38	0.63
1	1.2	1.2	2.3	1.2	2.0
10	3.8	3.8	7.3	3.8	6.3
100	12	12	23	12	20

For transmitters rated a maximum output power not listed above, the recommended separation distance d in meters (m) can be estimated using the equation applicable to the frequency of the transmitter, where P is the maximum output power rating of the transmitter in watts (W) according to the transmitter manufacturer.

NOTE 1: At 80 MHz and 800 MHz, the separation distance for the higher frequency range applies.

NOTE 2: These guidelines may not apply in all situations. Electromagnetic propagation is affected by absorption and reflection from structures, objects and people.

Guidance and manufacturer's declaration – electromagnetic immunity

The LMD-1530MD is intended for use in an electromagnetic environment in which radiated RF disturbances are controlled. Portable RF communications equipment should be used no closer than 30 cm (12 inches) to any part of the LMD-1530MD. Otherwise, degradation of the performance of this equipment could result.

Immunity test	Band ^a	Service ^a	Modulation	IEC 60601 test level	Compliance level
Proximity fields from RF wireless communications equipment IEC 61000-4-3	380 – 390 MHz	TETRA 400	Pulse modulation 18 Hz	27 V/m	27 V/m
	430 – 470 MHz	GMRS 460 FRS 460	FM ±5 kHz deviation 1 kHz sine	28 V/m	28 V/m
	704 – 787 MHz	LTE Band 13, 17	Pulse modulation 217 Hz	9 V/m	9 V/m
	800 – 960 MHz	GSM 800/900 TETRA 800 iDEN 820 CDMA 850 LTE Band 5	Pulse modulation 18 Hz	28 V/m	28 V/m
	1,700 – 1,990 MHz	GSM 1800 CDMA 1900 GSM 1900 DECT LTE Band 1, 3, 4, 25 UMTS	Pulse modulation 217 Hz	28 V/m	28 V/m
	2,400 – 2,570 MHz	Bluetooth WLAN 802. 11 b/g/n RFID 2450 LTE Band 7	Pulse modulation 217 Hz	28 V/m	28 V/m
	5,100 – 5,800 MHz	WLAN 802. 11 a/n	Pulse modulation 217 Hz	9 V/m	9 V/m

NOTE: These guidelines may not apply in all situations. Electromagnetic propagation is affected by absorption and reflection from structures, objects and people.

^a For some services, only the uplink frequencies are included.

Caution

When you dispose of the unit or accessories, you must obey the laws in the relative area or country and the regulations in the relative hospital regarding environmental pollution.



Warning on power connections

- Use a proper power cord for your local power supply.
1. Use the approved Power Cord (3-core mains lead) / Appliance Connector / Plug with earthing-contacts that conforms to the safety regulations of each country if applicable.
 2. Use the Power Cord (3-core mains lead) / Appliance Connector / Plug conforming to the proper ratings (Voltage, Ampere).

If you have questions on the use of the above Power Cord / Appliance Connector / Plug, please consult a qualified service personnel.



Warning on power connections for medical use

Customers in the U.S.A. and Canada should use the following type of power cord.
Customers in other countries or regions should use the power cord prescribed by their country or region.

	U.S.A. and Canada
Plug type	HOSPITAL GRADE*
Cord type	Min. Type SJT
	Min. 18 AWG
Minimum rating for plug and appliance couplers	10 A / 125 V
Safety approval	UL Listed and CSA

* Note: Grounding reliability can only be achieved when the equipment is connected to an equivalent receptacle marked “Hospital Only” or “Hospital Grade”.

WARNING

The apparatus shall not be exposed to dripping or splashing. No objects filled with liquids, such as vases, shall be placed on the apparatus.

WARNING

Make sure the surface is wide enough so that this apparatus’s width and depth don’t exceed the surface’s edges.

If not, this apparatus may lean or fall over and cause an injury.

Warning

To prevent injury, if mounting the unit using a mounting arm, wall fixture, or other mounting device prepared by the customer, mount the unit securely as described in the instruction manual provided with the mounting device. Check beforehand that the mounting device used has sufficient strength to support the added weight of the unit.

Check yearly that the mounting device is securely attached.

Consult with Sony qualified personnel for the following types of installation location.

- Wall mount
- Ceiling mount
- Mounting arm

Caution

The unit is not disconnected from the AC power source (mains) as long as it is connected to the wall outlet, even if the unit itself has been turned off.



Caution

Do not use the device in a MR (Magnetic Resonance) environment.

It may cause a malfunction, fire, and unwanted movement.

For the customers in the U.S.A. and Canada

(Hg) Lamp contains mercury. Dispose according to applicable local, state/ province and federal laws. For additional information, see www.sony.com/mercury



Disposal of Old Electrical & Electronic Equipment (Applicable in Republic of India)

This symbol indicates that this product and its components, consumables, parts or spares thereof shall not be treated as household waste and may not be dropped in garbage bins. Product owners are advised to deposit their product at the nearest collection point for the recycling of electrical and electronic equipment. Your co-operation shall facilitate proper disposal & help prevent potential negative consequences/hazards to the environment and human health, which could otherwise be caused by inappropriate waste disposal including improper handling, accidental breakage, damage and/ or improper recycling of e-waste. The recycling of materials will help to conserve natural resources. For more detailed information about recycling of this product, please contact your local civic office, your household waste disposal service provider or the store where you made the purchase. You may contact our company’s toll free number in India for assistance. Toll Free: 1800-103-7799

Visit: www.sony.co.in for product recycling

Reduction in the Use of Hazardous Substances in Electrical & Electronic Equipment (Applicable in Republic of India)

This product and its components, consumables, parts or spares comply with the hazardous substances restriction of India’s E-Waste (Management) Rules. The maximum allowable concentrations of the restricted substances are 0.1% by weight in homogenous materials for Lead, Mercury, Hexavalent Chromium, Polybrominated Biphenyls (PBB) and Polybrominated Diphenyl Ethers (PBDE), and 0.01% by weight in homogenous materials for Cadmium, except for the exemptions specified in Schedule II of the aforesaid Rules.

For the customers in the U.S.A.

SONY LIMITED WARRANTY - Please visit <http://www.sony.com/psa/warranty> for important information and complete terms and conditions of Sony's limited warranty applicable to this product.

For the customers in Canada

SONY LIMITED WARRANTY - Please visit <http://www.sonybiz.ca/pro/lang/en/ca/article/resources-warranty> for important information and complete terms and conditions of Sony's limited warranty applicable to this product.

For the customers in Europe

Sony Professional Solutions Europe - Standard Warranty and Exceptions on Standard Warranty. Please visit https://pro.sony/en_GB/support-services/warranty/support-professional-solutions-europe-standard-product-warranty for important information and complete terms and conditions.

For the customers in Korea

SONY LIMITED WARRANTY - Please visit <http://bpeng.sony.co.kr/handler/BPAS-Start> for important information and complete terms and conditions of Sony's limited warranty applicable to this product.

Table of Contents

Precaution	12
On Safety	12
On Installation	12
About the LCD Panel	12
On Burn-in	12
On a Long Period of Use	12
On Cleaning	13
Disposal of the Unit	13
Recommendation to Use more than One Unit	13
On Repacking	13
On Fan Error	13
On Moisture Condensation	13
To prolong the life of the unit	13
On simultaneous use with an electrosurgical knife, etc.	13
Features	14
Location and Function of Parts and Controls	15
Front Panel	15
Input Signals and Adjustable/Setting Items	16
Rear Panel	17
Connecting the AC Power Cord	19
Attaching the Input Adaptor	19
Removing the Connector Cover	20
Selecting the Default Settings	20
Selecting the Menu Language	22
Using the Menu	23
Adjustment Using the Menus	24
Items	24
Adjusting and Changing the Settings	24
STATUS menu.....	24
COLOR TEMP/BAL menu	25
USER CONTROL menu.....	25
SYSTEM SETTING menu	26
REMOTE menu	27
KEY INHIBIT menu.....	28
Troubleshooting	28
Specifications	29
Dimensions	33

Precaution

On Safety

- Operate the unit only with a power source as specified in the “Specifications” section.
- A nameplate indicating operating voltage, etc., is located on the rear panel.
- Should any solid object or liquid fall into the cabinet, unplug the unit and have it checked by qualified personnel before operating it any further.
- Do not drop or place heavy objects on the power cord. If the power cord is damaged, turn off the power immediately. It is dangerous to use the unit with a damaged power cord.
- Unplug the unit from the wall outlet if it is not to be used for several days or more.
- Disconnect the power cord from the AC outlet by grasping the plug, not by pulling the cord.
- The socket-outlet shall be installed near the equipment and shall be easily accessible.

On Installation

- Prevent internal heat build-up allowing adequate air circulation.
Do not place the unit on surfaces (rugs, blankets, etc.) or near materials (curtains, draperies) that may block the ventilation holes.
- Do not install the unit near heat sources such as radiators or air ducts, or in a place subject to direct sunlight, excessive dust, mechanical vibration or shock.
- Do not place the monitor near equipment which generates magnetism, such as a transformer or high voltage power lines.

About the LCD Panel

- The LCD panel fitted to this unit is manufactured with high precision technology, giving a functioning pixel ratio of at least 99.99%. Thus a very small proportion of pixels may be “stuck”, either always off (black), always on (red, green, or blue), or flashing. In addition, over a long period of use, because of the physical characteristics of the liquid crystal display, such “stuck” pixels may appear spontaneously. These problems are not a malfunction.
- Do not leave the LCD screen facing the sun as it can damage the LCD screen. Take care when you place the unit by a window.

- Do not push or scratch the LCD screen. Do not place a heavy object on the LCD screen. This may cause the screen to lose uniformity.
- If the unit is used in a cold place, a residual image may appear on the screen. This is not a malfunction. When the monitor becomes warm, the screen returns to normal.
- The screen and the cabinet become warm during operation. This is not a malfunction.

On Burn-in

For LCD panel, permanent burn-in may occur if still images are displayed in the same position on the screen continuously, or repeatedly over extended periods.

Images that may cause burn-in

- Masked images with aspect ratios other than 15:9
- Color bars or images that remain static for a long time
- Character or message displays that indicate settings or the operating state

To reduce the risk of burn-in

- Turn off the character displays
Press the MENU button to turn off the character displays. To turn off the character displays of the connected equipment, operate the connected equipment accordingly. For details, refer to the operation manual of the connected equipment.
- Turn off the power when not in use
Turn off the power if the viewfinder is not to be used for a prolonged period of time.

On a Long Period of Use

Due to the characteristics of LCD panel, displaying static images for extended periods, or using the unit repeatedly in a high temperature/high humidity environments may cause image smearing, burn-in, areas of which brightness is permanently changed, lines, or a decrease in overall brightness.

In particular, continued display of an image smaller than the monitor screen, such as in a different aspect ratio, may shorten the life of the unit. Avoid displaying a still image for an extended period, or using the unit repeatedly in a high temperature/high humidity environment such as an airtight room, or around the outlet of an air conditioner.

To prevent any of the above issues, we recommend reducing brightness slightly, and to turn off the power whenever the unit is not in use.

On Cleaning

Before cleaning

Be sure to disconnect the AC power cord from the AC outlet.

On cleaning the monitor

A material that withstands disinfection is used for the medical use LCD monitor. When solvents such as benzene or thinner, or acid, alkaline or abrasive detergent, or chemical cleaning cloth are used for the monitor surface, the performance of the monitor may be impaired or the finish of the surface may be damaged.

Take care with respect to the following:

- Clean the monitor surface with a 50 to 70 v/v% concentration of isopropyl alcohol or a 76.9 to 81.4 v/v% concentration of ethanol using a swab method. Wipe the monitor surface gently (wipe using less than 1 N force).
- Stubborn stains may be removed with a soft cloth such as a cleaning cloth lightly dampened with mild detergent solution using a swab method and then clean using the above chemical solution. Never use solvents such as benzene or thinner, or acid, alkaline or abrasive detergent, or chemical cleaning cloth for cleaning or disinfection, as they will damage the monitor surface.
- Do not use unnecessary force to rub the monitor surface with a stained cloth. The monitor surface may be scratched.
- Do not keep the monitor surface in contact with a rubber or vinyl resin product for a long period of time. The finish of the surface may deteriorate or the coating may come off.

Disposal of the Unit

- Do not dispose of the unit with general waste. Do not include the monitor with household waste.
- The fluorescent tube includes mercury. Dispose of the monitor in accordance with the regulations of your local sanitation authority.

Recommendation to Use more than One Unit

As problems can occasionally occur for the monitor, when the monitor is used for safety control of personnel, assets or stable picture, or for emergencies, we strongly recommend you use more than one unit or prepare a spare unit.

On Repacking

Do not throw away the carton and packing materials. They make an ideal container which to transport the unit.

If you have any questions about this unit, contact your authorized Sony dealer.

On Fan Error

The fan for cooling the unit is built in. When the fan stops and the  indicator on the front panel blinks for fan error indication, turn off the power and contact an authorized Sony dealer.

On Moisture Condensation

If the unit is brought directly from a cold place to a warm place, or the unit is warm and the ambient temperature cools suddenly (by air-conditioning, for example), moisture may condense on the surface or inside of the unit.

This is called moisture condensation, and is not a malfunction of the product itself, although it may cause damage to the unit.

Leave the unit in a condensation free area.

If moisture condensation has occurred, turn off the unit and do not use it until moisture condensation has evaporated.

To prolong the life of the unit

Turn off the power to preserve the performance when not in use for a prolonged time.

On simultaneous use with an electrosurgical knife, etc.

If this unit is used together with an electrosurgical knife, etc., the picture may be disturbed, warped or otherwise abnormal as a result of strong radio waves or voltages from the device. This is not a malfunction.

When you use this unit simultaneously with a device from which strong radio waves or voltages are emitted, confirm the effect of this before using such devices, and install this unit in a way that minimizes the effect of radio wave interference.

Features

The LCD Monitor is to provide color video displays of images from medical imaging systems on LCD (liquid crystal display) panel.

Liquid crystal and color filters are laid on the front of flat light source (backlight) on the LCD panel. And then, the LCD panel displays images by controlling the aperture of the liquid crystal according to input signals.

Compliance with medical safety standards in U.S.A., Canada and Europe

IEC 60601-1 and product safety standards in the U.S.A., Canada and Europe have been obtained for this monitor. The monitor is designed for use in the medical treatment field, with screen protect panel, etc.

High brightness LCD panel

Because of the monitor's high brightness, high contrast and wide viewing angle technology, it can be used under various lighting conditions.

Monitor stand with tilt function

As the stand with tilt function is equipped normally for the monitor, you can use it easily on the desk top.

Tally lamp

The green LED lamp is used for the tally lamp. You can check the status of the monitor, controlling the lamp from the external remote.

Multi-format

The monitor supports the video, Y/C, RGB, component and HDMI¹⁾ input signals.

Both NTSC and PAL color systems are supported, and the appropriate color system is selected automatically. HD/SD-SDI signals can be available when input adaptor BKM-341HS (optional) is used.

For more information, see "Video signal formats" (page 31).

¹⁾ The terms HDMI and HDMI High-Definition Multimedia Interface, and the HDMI Logo are trademarks or registered trademarks of HDMI Licensing Administrator, Inc. in the United States and other countries.

Blue only mode

In the blue only mode, an apparent monochrome display is obtained with all three of the R/G/B cathodes driven with a blue signal. This facilitates color saturation and phase adjustments and observation of signal noise.

Analog RGB/component input connectors

Analog RGB or component signals from video equipment can be input through these connectors.

Y/C input connectors

Y/C signals of the video signal can be input through this connector.

External sync input

When the EXT SYNC button is in the on position, the unit can be operated on the sync signal supplied from an external sync generator.

Automatic termination (connector with mark only)

The input connector is terminated internally at 75 ohms when nothing has been connected to the output connector. If a cable is connected to the output connector, the internal terminal is automatically released and the signals input to the input connector are output to the output connector (loop-through).

Select color temperature and gamma mode

You can select the color temperature from among three (HIGH, LOW and LOW2) settings and gamma mode from among five settings. You can also adjust the color temperature to the appropriate setting.

Aspect setting

You can set the monitor to 4:3 or 16:9 display mode according to the input video signal.

Scan setting

You can set the display size to normal scan, over scan or full screen.

Key inhibit function

You can inhibit a key function to prevent misoperation.

Select language display

You can select from seven display languages English, Chinese, Japanese, Italian, Spanish, German and French.

External remote control function

You can directly select the input signal, aspect, etc., by operating the equipment connected to the PARALLEL REMOTE terminal.

I/P mode setting

This unit is equipped with an I/P mode setting function that is used to minimize picture delay due to the signal conversion process.

Two kinds of ground terminals

Two kinds of ground terminals are built into the monitor to equal the electric potential.

Location and Function of Parts and Controls

Front Panel

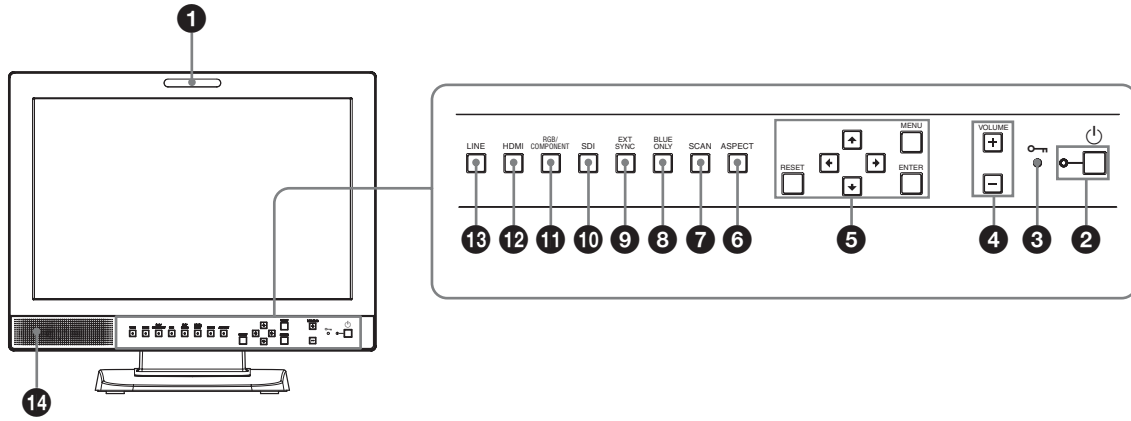

1 Tally lamp

Turning this lamp on or off can be done with a PARALLEL REMOTE connector.

For details, see “Pin assignment” (page 30).

2 (standby) switch and indicator

Press to turn on the power when this unit is in standby mode. The indicator turns on. Press again to set the monitor in standby mode. The indicator goes out.

3 (key inhibit) indicator

Lights when the key inhibit function works. The indicator blinks when fan error occurs.

For details on the key inhibit, see “KEY INHIBIT menu” (page 28).

4 VOLUME buttons

Press the + button to increase the volume or the – button to decrease it.

5 Menu operation buttons

Displays or sets the on-screen menu.

(arrow) buttons

Select the menu or make various adjustments.

MENU button

Press to display the on-screen menu.

Press again to clear the menu.

RESET button

Resets the value of an item back to the previous value.

This button functions when the menu item is adjusted (displayed) on the screen.

ENTER button

Press to confirm a selected item on the menu.

6 ASPECT select button

Press to set the aspect ratio of the picture, 16:9 or 4:3.

7 SCAN select button

You can change the scan size of the picture.

Press to change the scan size among over (5% over scan), normal (0% scan) and full screen set on the SCAN menu (page 26).

8 BLUE ONLY button

Press to eliminate the red and green signals. Only blue signal is displayed as a monochrome picture on the screen. This mode is convenient for chroma and phase adjustments and monitoring of signal noise.

9 EXT SYNC (external sync) button

Press to operate the unit on an external sync signal through the EXT SYNC IN connector.

The EXT SYNC button works when the component/RGB signals are input.

10 SDI button

Press to monitor the signal through the OPTION IN connector.

11 RGB/COMPONENT button

Press to monitor the signal through the RGB/COMPONENT input connector.

12 HDMI button

Press to monitor the signal through the HDMI IN connector.

13 LINE button

Press to monitor the signal through the LINE input connector.

14 Speaker

The audio signal selected by the input select button (10 SDI button, 11 RGB/COMPONENT button, 12 HDMI button or 13 LINE button) on the front panel is output.

Input Signals and Adjustable/Setting Items

Item	Input signal									
	Video, Y/C	B & W	Component		RGB		SDI*4	HDMI		
			SD	HD	SD	HD	SD/HD	SD	HD	DVI*5
CONTRAST	○	○	○	○	○	○	○	○	○	○
BRIGHT	○	○	○	○	○	○	○	○	○	○
CHROMA	○	×	○	○	×	×	○	○	○	×
PHASE	○ (NTSC)	×	×	×	×	×	×	×	×	×
APERTURE	○	○	○	○	○	○	○	○	○	×
COLOR TEMP	○	○	○	○	○	○	○	○	○	○
COMPONENT LEVEL*1	×	×	○ (480/60I)	×	×	×	×	×	×	×
NTSC SETUP	○ (NTSC)	○ (480/60I)	×	×	×	×	×	×	×	×
GAMMA	○	○	○	○	○	○	○	○	○	○
SCAN	○	○	○	○	○	○	○	○	○	×
ASPECT	○	○	○	○*2	○	○*2	○	○	○*2	×
BLUE ONLY	○	×	○	○	○	○	○	○	○	×
I/P MODE*3	○	○	○	○	○	○	○	○	○	×
EXT SYNC	×	×	○	○	○	○	×	×	×	×
SD PIXEL MAPPING COMPOSITE&Y/C	○	○	×	×	×	×	×	×	×	×
SD PIXEL MAPPING RGB/COMPONENT	×	×	○	×	○	×	×	×	×	×

○ : Adjustable/can be set
 × : Not adjustable/cannot be set

*1 When a component signal (480/60I) is input, this can be switchable.

*2 When a 480/60P or 576/50P signal is input, this can be switchable.

*3 When an interlace signal is input, this can be switchable.

*4 When BKM-341HS is used, SDI signals can be input.

*5 When a PC signal is input to the HDMI IN connector using a DVI conversion cable, this can be adjusted.

Rear Panel

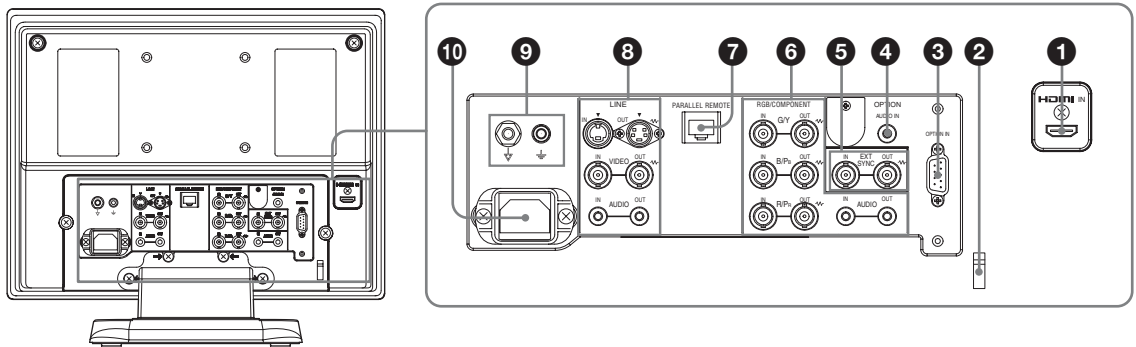

1 HDMI IN connector

HDMI (High-Definition Multimedia Interface) is an interface that supports both video and audio on a single digital connection, allowing you to enjoy high quality digital picture and sound. The HDMI specification supports HDCP (High-bandwidth Digital Content Protection), a copy protection technology that incorporates coding technology for digital video signals.

Notes

- Use HDMI compliant cable (optional) with HDMI logo.
- Color noise may appear on the edge of the screen depending on the connected device. This is not a malfunction.

2 HDMI cable holder

Secures the HDMI cable (Ø7 mm or less).

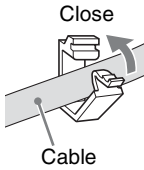

3 OPTION IN connector (D-sub 9-pin, female)

Inputs HD/SD-SDI signals when optional Sony BKM-341HS is connected. Press the SDI button to select the signal.

Note

Do not connect the equipment other than BKM-341HS. It causes damage to the unit or the equipment.

4 OPTION AUDIO IN connector (phono jack)

Inputs an audio signal if the BKM-341HS is connected to the OPTION IN connector. Press the SDI button to monitor the audio signal.

5 EXT SYNC IN/OUT (external sync) connectors (BNC)

Press the EXT SYNC button to use the sync signal through this connector.

IN connector

When this unit operates on an external sync signal, connect the reference signal from a sync generator to this connector.

Note

When inputting a video signal with the jitters, etc. the picture may be disturbed. We recommend using the TBC (time base corrector).

OUT connector

Loop-through output of the IN connector. Connect to the external sync input of video equipment to be synchronized with this unit. When the cable is connected to this connector, the 75-ohms termination of the input is automatically released, and the signal input to the IN connector is output from this connector.

6 RGB/COMPONENT connectors

Analog RGB signal or component (Y/P_B/P_R) signal input connectors and their loop-through output connectors.

Press the RGB/COMPONENT button to monitor the signal input through these connectors.

G/Y, B/P_B, R/P_R IN/OUT (BNC)

These are the input/output connectors for an analog RGB and a component (Y/P_B/P_R) signal. Unless an external sync signal is input, the monitor is synchronized with the sync signal contained in the G/Y signal.

AUDIO IN/OUT (phono jack)

When using an analog RGB or a component signal as a video signal, use these jacks for the input/output of an audio signal. Connect them to the audio input/output jacks on equipment such as a VCR.

7 PARALLEL REMOTE connector (modular connector, 8-pin)

Forms a parallel switch and controls the monitor externally.

When the unit is shipped from the factory, a connector cover is attached to this connector. Remove it before using the connector.

For removing the connector cover, see page 20.

For details on the pin assignment and factory setting function assigned to each pin, see page 30.



Caution

- Do not come into contact with this connector and patients at the same time. Doing so may result in a generation of voltage that can be harmful to patients if the unit is malfunctioning. Always disconnect the power cord before connecting and disconnecting connectors.
- For safety, do not connect the connector to peripheral device wiring that might have excessive voltage. Follow the instructions for use for this port.

8 LINE connectors

Line input connectors for Y/C separate, composite video and audio signals and their loop-through output connectors.

Press the LINE button to monitor the signal input through these connectors.

If you input signals to both Y/C IN and VIDEO IN, the signal input to the Y/C IN is selected.

Y/C IN/OUT (4-pin mini-DIN)

These are the input/output connectors for a Y/C separate signal. Connect them to the Y/C separate input/output connectors on equipment such as a VCR, video camera, or another monitor.

VIDEO IN/OUT (BNC)

These are the input/output connectors for a composite video signal. Connect them to the composite video input/output connectors on equipment such as a VCR, video camera, or another monitor.

AUDIO IN/OUT (phono jack)

These are the input/output jacks for an audio signal. Connect them to the audio input/output jacks on equipment such as a VCR.

9 ⚡/⊥ (Equipotential/Function Earth) terminal

⚡ (equipotential) terminal

Connects the equipotential plug.

⊥ (function earth) terminal

Connects the earth cable.

10 AC IN socket

Connect the supplied AC power cord.



WARNING

Using this unit for medical purposes

The connectors on this unit are not isolated.

Do not connect any device other than one which conforms to IEC 60601-1 standards.

When an information technology device or AV device that uses an alternating current is connected, current leakage may result in an electric shock to the patient or operator.

If use of such a device is unavoidable, isolate its power supply by connecting an isolation transformer, or by connecting an isolator between the connecting cables. After implementing these measures, confirm that the reduced risk now conforms to IEC 60601-1 standards.

Connecting the AC Power Cord

- 1 Plug the AC power cord into the AC IN socket on the rear panel. Then, attach the AC plug holder (supplied) to the AC power cord.

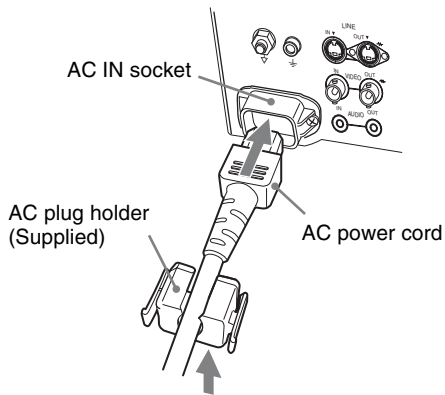

- 2 Slide the AC plug holder over the cord until it locks.

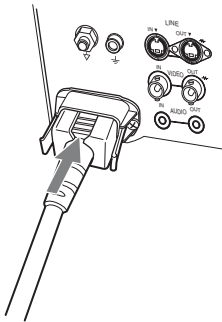

To disconnect the AC power cord

Pull out the AC plug holder while pressing the lock levers.

Attaching the Input Adaptor

Before attaching the input adaptor, disconnect the power cord.

BKM-341HS

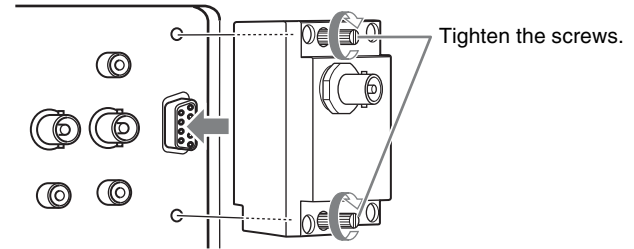

Note

Do not connect the equipment other than BKM-341HS. It causes damage to the unit or the equipment.

Removing the Connector Cover

When the unit is shipped from the factory, a connector cover is attached to the PARALLEL REMOTE connector.

To use the connector, remove the connector cover as follows.

Before removing the connector cover, disconnect the power cord.

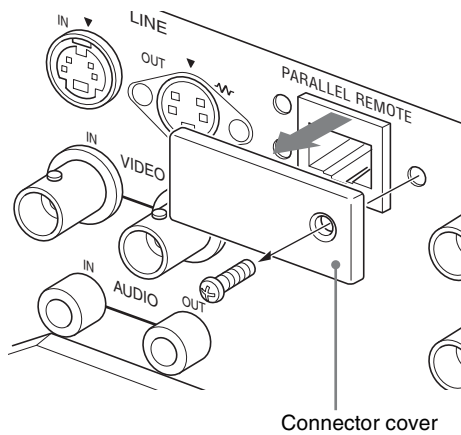

- 1** Remove the screw of the connector cover.
- 2** Remove the connector cover.

Save the screw and cover, so that you can reattach the cover if necessary.

Selecting the Default Settings

When you turn on the unit for the first time after purchasing it, select the area where you intend to use this unit from among the options.

The default setting values for each area

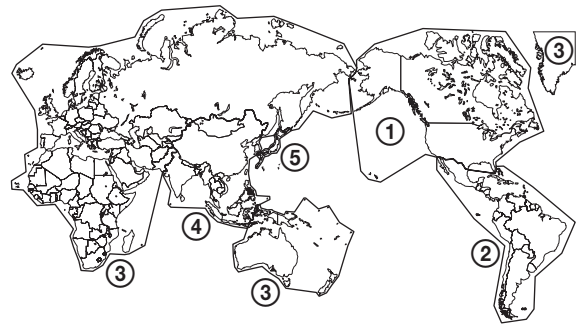

		COLOR TEMP	COMPONENT LEVEL	NTSC SETUP
① NORTH AMERICA		LOW	BETA7.5	7.5
② LATIN AMERICA	ARGENTINA	LOW	SMPTE	0
	PARAGUAY	LOW	SMPTE	0
	URUGUAY	LOW	SMPTE	0
NTSC&PAL-M AREA	OTHER AREA	LOW	BETA7.5	7.5
③ AFRICA AUSTRALASIA EUROPE MIDDLE-EAST		LOW	SMPTE	0
④ ASIA EXCEPT JAPAN	NTSC AREA	LOW	BETA7.5	7.5
	PAL AREA	LOW	SMPTE	0
⑤ JAPAN		HIGH	SMPTE	0

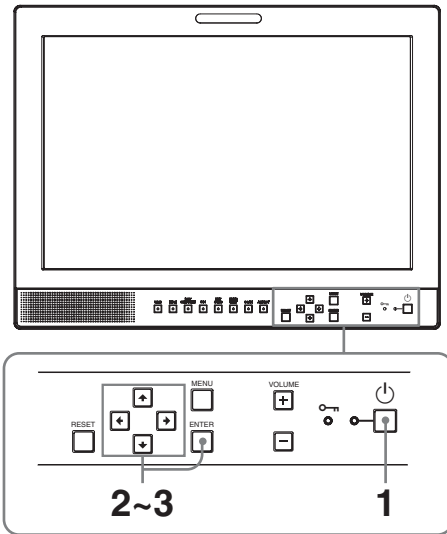

② If LATIN AMERICA is selected:

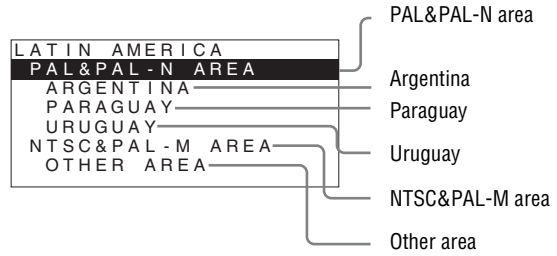

④ If ASIA EXCEPT JAPAN is selected:

Customers who will use this unit in the shaded areas shown in the map below should select NTSC AREA. Other customers should select PAL AREA.

1 Press the (standby) switch.

The power is turned on and the SELECT SETTING screen appears.

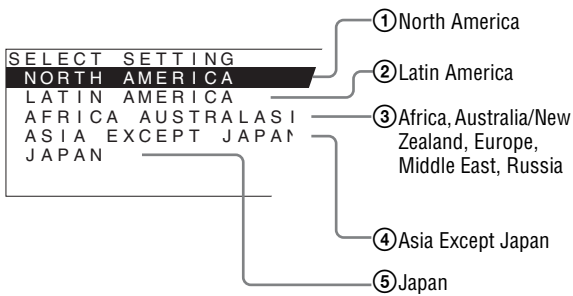
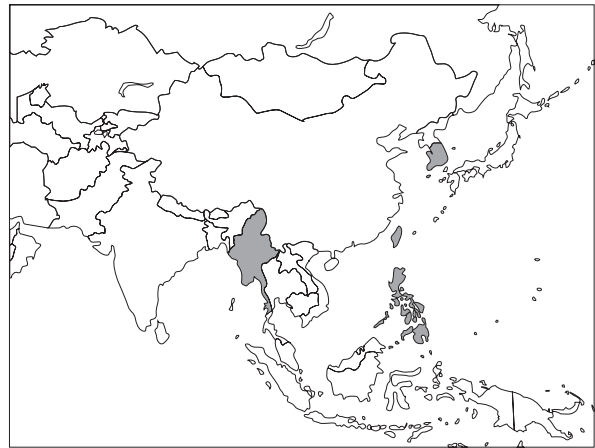

2 Press the or button to select the area where you intend to use the unit and press the or ENTER button.

If you select either ①, ③ or ⑤

The confirmation screen is displayed. Confirm the selected area. When the setting is wrong, press the button to return to the previous screen.

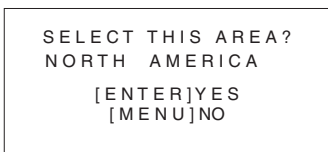

If you select either ② or ④

One of the following screens appears. Press the or button to narrow the area further and then press the or ENTER button.

The confirmation screen is displayed. Confirm the selected area. When the setting is wrong, press the button to return to the previous screen.

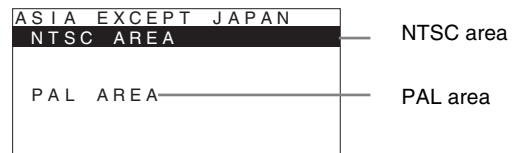

3 Press the or button to narrow the area further and then press the or ENTER button.

The SELECT SETTING screen disappears and the menu item settings suitable for the selected area are applied.

Note

When you have selected the wrong area, set the following items using the menu.

- COLOR TEMP (on page 25)
- COMPONENT LEVEL (on page 26)
- NTSC SETUP (on page 26)

See “The default setting values for each area” (page 20) on the setting value.

Selecting the Menu Language

You can select one of seven languages (English, Chinese, Japanese, Italian, Spanish, German, French) for displaying the menu and other on-screen displays. “ENGLISH (English)” is selected in the default setting. The current settings are displayed in place of the ■ marks on the illustrations of the menu screen.

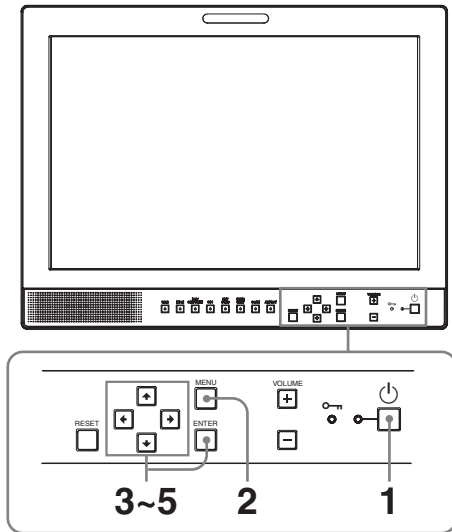

1 Press the (standby) switch to turn on the unit.

2 Press the MENU button.

The menu appears.
The menu presently selected is shown in yellow.

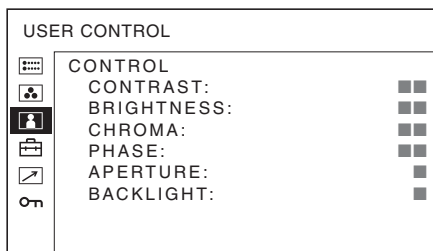

3 Press the or button to select SYSTEM SETTING menu, then press the or ENTER button.

The setting items (icons) in the selected menu are displayed in yellow.

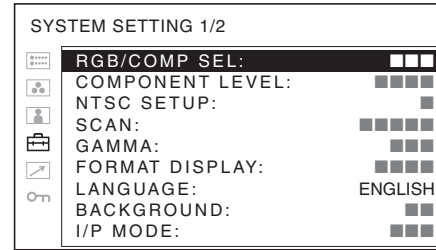

4 Press the or button to select “LANGUAGE,” then press the or ENTER button.

The selected item is displayed in yellow.

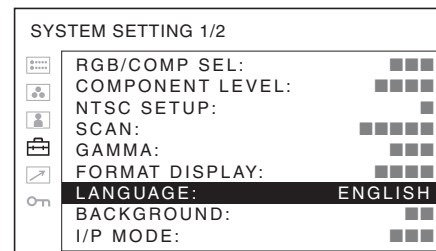

5 Press the or button to select a language, then press the ENTER button.

The menu changes to the selected language.

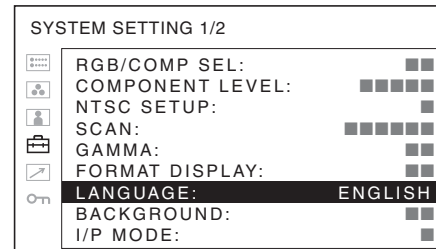

To clear the menu

Press the MENU button.

The menu disappears automatically if a button is not pressed for one minute.

Using the Menu

The unit is equipped with an on-screen menu for making various adjustments and settings such as picture control, input setting, set setting change, etc. You can also change the menu language displayed in the on-screen menu.

To change the menu language, see “Selecting the Menu Language” on page 22.

The current settings are displayed in place of the ■ marks on the illustrations of the menu screen.

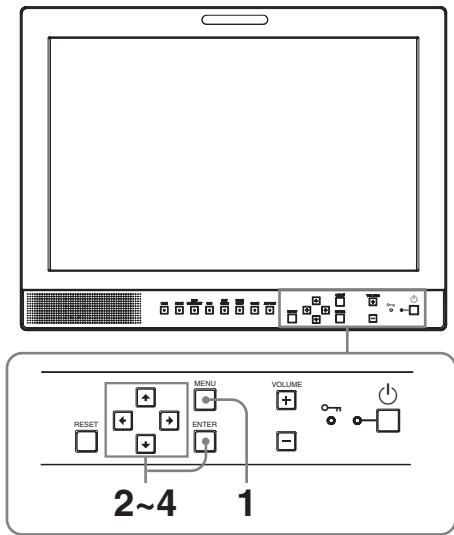

1 Press the MENU button.

The menu appears.
The menu presently selected is shown in yellow.

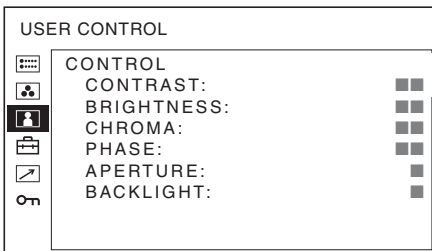

2 Press the ↑ or ↓ button to select a menu, then press the → or ENTER button.

The menu icon presently selected is shown in yellow and setting items are displayed.

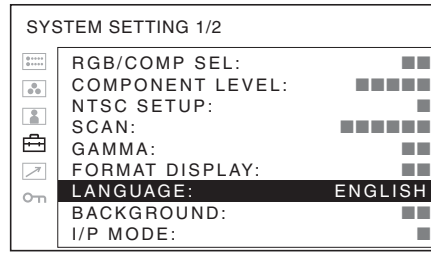

3 Press the ↑ or ↓ button to select the item, then press the → or ENTER button.

The item to be changed is displayed in yellow.

Note

If the menu consists of multiple pages, press ↑ or ↓ button to go to the desired menu page.

4 Make the setting or adjustment on an item.

When changing the adjustment level:

To increase the number, press the ↑ button.
To decrease the number, press the ↓ button.
Press the ENTER button to confirm the number, then restore the original screen.

When changing the setting:

Press the ↑ or ↓ button to change the setting.
Press the ENTER button to confirm the setting.

Notes

- An item displayed in black cannot be accessed. You can access the item if it is displayed in white.
- If the key inhibit has been turned on, all items are displayed in black. To change any of the items, turn the key inhibit to OFF first.

For details on the key inhibit, see “KEY INHIBIT menu” (page 28).

To clear the menu

Press the MENU button.
The menu disappears automatically if a button is not pressed for one minute.

About the memory of the settings

The settings are automatically stored in the monitor memory.

To reset items that have been adjusted

Pressing the RESET button while you are adjusting any of the menu items resets the menu item to the previous setting.

Adjustment Using the Menus

Items

The screen menu of this monitor consists of the following items.

STATUS (the items indicate the current settings.)

For the video input

FORMAT
COLOR TEMP
GAMMA
COMPONENT LEVEL
NTSC SETUP
RGB/COMP SEL
SCAN MODE
Model name and serial number
OPTION

For the DVI input

FORMAT
fH
fV
COLOR TEMP
Model name and serial number
OPTION

COLOR TEMP/BAL

COLOR TEMP
MANUAL ADJUSTMENT

USER CONTROL

CONTROL

SYSTEM SETTING

RGB/COMP SEL
COMPONENT LEVEL
NTSC SETUP
SCAN
GAMMA
FORMAT DISPLAY
LANGUAGE
BACKGROUND
I/P MODE
SD PIXEL MAPPING

REMOTE

PARALLEL REMOTE

1PIN
2PIN
3PIN
4PIN
6PIN
7PIN
8PIN

KEY INHIBIT

KEY INHIBIT

Adjusting and Changing the Settings

STATUS menu

The STATUS menu is used to display the current status of the unit. The following items are displayed:

For the video input

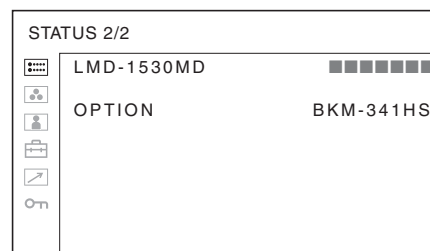
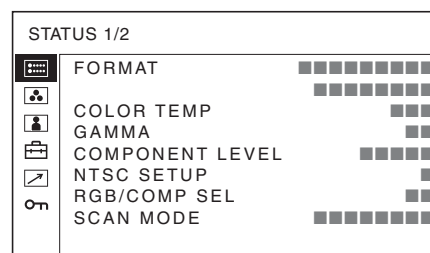

- Signal format
- Color temperature
- Gamma
- Component level
- NTSC setup
- RGB/Component select
- Scan mode
- Model name and serial number
- Option

For the DVI input

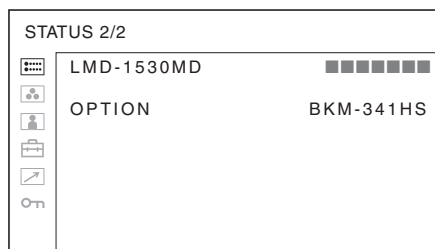
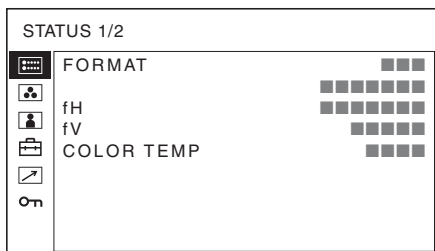

- Signal format
- fH
- fV
- Color temperature
- Model name and serial number
- Option

COLOR TEMP/BAL menu

The COLOR TEMP/BAL menu is used for adjusting the picture white balance.

You need to use the measurement instrument to adjust the white balance.

Recommended: Konica Minolta color analyzer CA-210

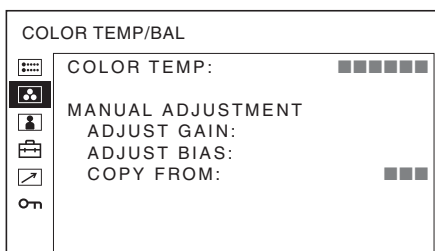

Submenu	Setting
COLOR TEMP	Selects the color temperature from among HIGH, LOW, USER setting and LOW2.

Submenu	Setting
MANUAL ADJUSTMENT	<p>If you set the COLOR TEMP to USER setting, the item displayed is changed from black to white, which means you can adjust the color temperature.</p> <ul style="list-style-type: none"> • ADJUST GAIN: Adjusts the color balance (GAIN). • ADJUST BIAS: Adjusts the color balance (BIAS). • COPY FROM: If you select HIGH, LOW or LOW2, the white balance data for the selected color temperature will be copied in the USER setting.

USER CONTROL menu

The USER CONTROL menu is used for adjusting the picture.

Items that cannot be adjusted depending on the input signal are displayed in black.

For details of input signal and adjustable / setting items, see page 16.

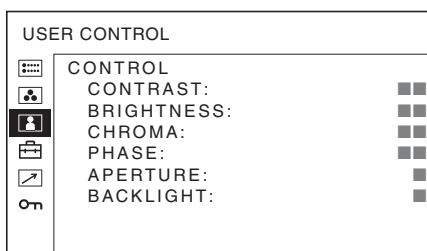

Submenu	Setting
CONTROL	<p>You can adjust the picture.</p> <ul style="list-style-type: none"> • CONTRAST: Adjusts the picture contrast. • BRIGHTNESS: Adjusts the picture brightness. • CHROMA: Adjusts color intensity. The higher the setting, the greater the intensity. The lower the setting, the lower the intensity. • PHASE: Adjusts color tones. The higher the setting, the more greenish the picture. The lower the setting, the more purplish the picture. • APERTURE: Adjusts the picture sharpness. The higher the setting, the sharper the picture. The lower the setting, the softer the picture. • BACKLIGHT: Adjusts the backlight. When the setting is changed, the brightness of the backlight is changed.

SYSTEM SETTING menu

The SYSTEM SETTING menu is used for setting the system. You can set the display language and so on. Items that cannot be adjusted depending on the input signal are displayed in black.

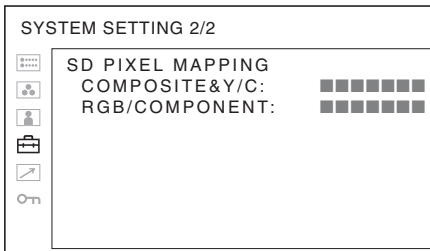
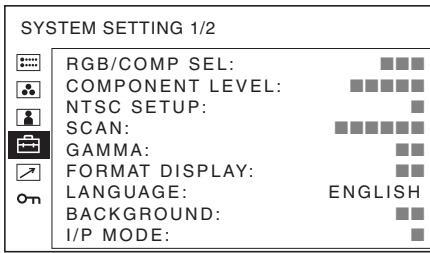

Submenu	Setting
RGB/COMP SEL	When a signal input via the RGB/COMPONENT connector is being monitored, based on the signal being input, select RGB or COMP (component).
COMPONENT LEVEL	Selects the component level from among three modes. <ul style="list-style-type: none"> • SMPTE: for 100/0/100/0 signal • BETA7.5: for 100/7.5/75/7.5 signal • BETA0: for 100/0/75/0 signal
NTSC SETUP	Selects the NTSC setup level from two modes. The 7.5 setup level is used mainly in North America. The 0 setup level is used mainly in Japan.
SCAN	Sets the scan size of the picture. Select from OFF and FULL. The display format changes depending on the mode selected. (See “Scan mode image” on page 27.) <ul style="list-style-type: none"> • OFF: Changes between over scan and normal scan. • FULL: Changes to over scan, normal scan or full screen.
GAMMA	Select the appropriate gamma mode. You can select from among five settings. When “3” is selected, the setting is roughly same as the gamma mode of the CRT (2.2).

Submenu	Setting
FORMAT DISPLAY	Selects the display mode of the signal format. <ul style="list-style-type: none"> • AUTO: The format is displayed for about 10 seconds when the input of the signal starts. • ON: The format is always displayed. • OFF: The display is hidden.
LANGUAGE	Selects the menu or message language from among seven languages. <ul style="list-style-type: none"> • ENGLISH: English • 中文: Chinese • 日本語: Japanese • ITALIANO: Italian • ESPAÑOL: Spanish • DEUTSCH: German • FRANÇAIS: French
BACKGROUND	Sets the brightness of the black bars appearing on the sides of the screen. <ul style="list-style-type: none"> • OFF: Displays a darker bar (black). • ON: Displays a brighter bar (gray).
I/P MODE (picture delay minimum)	Select to set the delay by the picture processing to the minimum level when the signal is input. <ul style="list-style-type: none"> • INTER-FIELD: Performs interpolation depending on the movement of the images between the fields. It takes longer than “LINE DOUBLER” for processing the picture. “INTER-FIELD” is the factory setting. • LINE DOUBLER: The processing time is shorter. Performs interpolation by repeating each line in the data receiving sequence regardless of the field. As the line flicker is displayed in this mode, it is available for checking the line flicker of the telop work and so on.

Submenu	Setting
SD PIXEL MAPPING	<p>Selects SD picture size (pixels) according to input signal format.</p> <ul style="list-style-type: none"> • COMPOSITE&Y/C: Set to monitor the signal input through the LINE connector (VIDEO IN or Y/C IN connector). • RGB/COMPONENT: Set to monitor the signal input through the RGB/COMPONENT connector. <p>When picture signals in the size of 720 x 576 (50i) (or 720 x 487 (60i)) are input Select 720 x 576 (or 720 x 487). This is the default setting. When 702 x 576 (or 712 x 483) is selected, all sides of the input picture are cut off by several pixels.</p> <p>When picture signals in the size of 702 x 576 (50i) (or 712 x 483 (60i)) or equivalent are input Select 702 x 576 (or 712 x 483). When 720 x 576 (or 720 x 487) is selected, a black border (of several pixels wide) appears around the input picture.</p>

Scan mode image

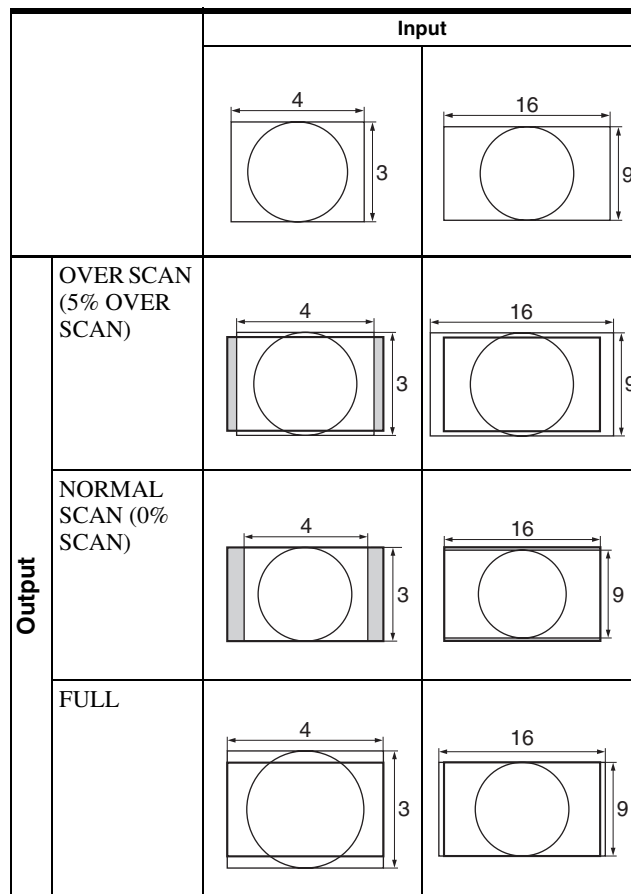

REMOTE menu

Select the PARALLEL REMOTE connector pins for which you want to change the function.

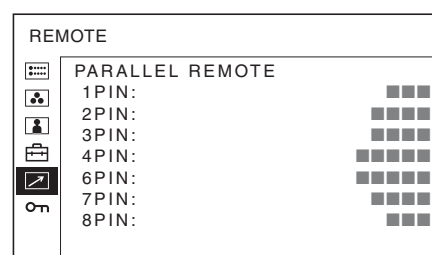

You can assign various functions to 1 to 4 pins and 6 to 8 pins. The following lists the functions you can assign to the pins.

REMOTE

- --- (“---”: No function is assigned.)
- LINE
- HDMI
- RGB/COMP
- 16:9
- 4:3

- NORMAL
- OVER
- TALLY G
- EXT SYNC
- BLUE ONLY
- FULL
- SDI

If you use the PARALLEL REMOTE function, you need to connect cables.

For more details, see page 30.

ON KEY INHIBIT menu

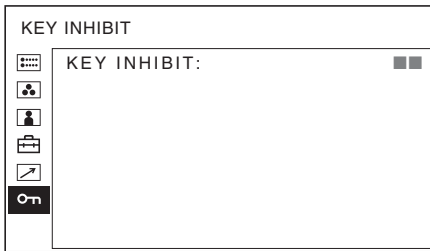

You can lock the setting so that they cannot be changed by an unauthorized user.

Select OFF or ON.

If you set to ON, all items are displayed in black, indicating the items are locked.

Troubleshooting

This section may help you isolate the cause of a problem and as a result, eliminate the need to contact technical support.

- **The display is colored in green or purple** → Select the correct input from the RGB/COMP SEL setting in the SYSTEM SETTING menu (page 26).
- **The unit cannot be operated** → The key protection function works. Set the KEY INHIBIT setting to OFF in the KEY INHIBIT menu.

Specifications

Picture performance

LCD panel	a-Si TFT Active Matrix
Picture size	15.3 type 334 × 200, 390 mm (W/H, Diagonal) (13 1/4 × 7 7/8, 15 3/8 inches)
Resolution	1280 × 768 dots (WXGA)
Viewing angle (LCD panel specifications)	(up/down/left/right, contrast > 10:1) 89°/89°/89°/89° (typical)
Scan	Normal 0% Over 5%
Aspect	15:9
Display color	16,770,000

Input/output connectors

Input

LINE input connectors

Y/C input 4-pin mini-DIN (1)

VIDEO input

BNC type (1), 1 Vp-p ±3 dB, negative synchronization

AUDIO input

Phono jack (1), -5 dBu 47 kilohms or higher

RGB/COMPONENT input connectors

BNC type (3)

RGB input 0.7 Vp-p ±3 dB, (Sync On Green, 0.3 Vp-p negative sync.)

Component input

0.7 Vp-p ±3 dB, (75% chrominance standard color bar signal)

AUDIO input

Phono jack (1), -5 dBu 47 kilohms or higher

OPTION IN connector

D-sub 9-pin (1), female

OPTION AUDIO IN connector

Phono jack (1), -5 dBu 47 kilohms or higher

External synchronized input connector

BNC type (1), 0.3 to 4 Vp-p ± bipolarity ternary or negative polarity binary

HDMI IN connector

HDMI (1)

PARALLEL REMOTE input connector

Parallel remote

Modular connector 8-pin (1)

Output

LINE output connectors

Y/C output 4-pin mini-DIN (1), Loop-through, with 75 ohms automatic terminal function

VIDEO output

BNC type (1), Loop-through, with 75 ohms automatic terminal function

AUDIO output

Phono jack (1), Loop-through

RGB/COMPONENT output connectors

RGB/Component output

BNC type (3), Loop-through, with 75 ohms automatic terminal function

AUDIO output

Phono jack (1), Loop-through

External synchronized output connector

BNC type (1), Loop-through, with 75 ohms automatic terminal function

Built-in speaker output

0.5 W (mono)

General

Power AC 100 V to 240 V, 50/60 Hz

Power consumption

Maximum: approx. 50 W

Input Current 1.0 A to 0.5 A

Operating conditions

Temperature

0 °C to 35 °C (32 °F to 95 °F)

Recommended temperature

20 °C to 30 °C (68 °F to 86 °F)

Humidity 30% to 85% (no condensation)

Pressure 700 hPa to 1060 hPa

Storage and transport conditions

Temperature

-20 °C to +60 °C (-4 °F to +140 °F)

Humidity 0% to 90%

Pressure 700 hPa to 1060 hPa

Accessories supplied

AC power cord (1)

AC plug holder (2)

Before Using This Unit (1)

CD-ROM (including the Instructions for Use) (1)

Service Contact List (1)

Information for Customers in Europe (1)

Optional accessories

HD/SD-SDI Input Adaptor

BKM-341HS

Medical Specifications

Protection against electric shock:

Class I

Protection against harmful ingress of water:

Ordinary

Degree of safety in the presence of a flammable anesthetic mixture with air or with oxygen or nitrous oxide:

Not suitable for use in the presence of a flammable anesthetic mixture with air or with oxygen or nitrous oxide

Mode of operation:

Continuous

Design and specifications are subject to change without notice.

Note

Always verify that the unit is operating properly before use. SONY WILL NOT BE LIABLE FOR DAMAGES OF ANY KIND INCLUDING, BUT NOT LIMITED TO, COMPENSATION OR REIMBURSEMENT ON ACCOUNT OF THE LOSS OF PRESENT OR PROSPECTIVE PROFITS DUE TO FAILURE OF THIS UNIT, EITHER DURING THE WARRANTY PERIOD OR AFTER EXPIRATION OF THE WARRANTY, OR FOR ANY OTHER REASON WHATSOEVER.

Pin assignment

PARALLEL REMOTE connector

Modular connector
(8-pin)

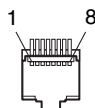

Pin number	Functions
1	Designating LINE input signal
2	Designating HDMI input signal
3	Designating RGB/COMPONENT input signal
4	16:9
5	GND
6	4:3
7	Selecting NORMAL
8	Selecting OVER

For details on function allocations, see *REMOTE menu* (page 27).

Wiring required to use the Remote Control

Connect the function you want to use with a Remote Control to the Ground (Pin 5).

Video signal formats

The unit is applicable to the following signal formats.

System	Total lines	Active lines	Frame rate	Scanning format	Aspect ratio	Signal standard
575/50I (PAL)	625	575	25	2:1 interlace	16:9/4:3	EBU N10 (PAL: ITU-R BT.624)
480/60I (NTSC) *1	525	483	30	2:1 interlace	16:9/4:3	SMPTE 253M (NTSC: SMPTE 170M)
576/50P	625	576	50	Progressive	16:9/4:3	ITU-R BT.1358
480/60P	525	483	60	Progressive	16:9/4:3	SMPTE 293M
1080/24P *1	1125	1080	24	Progressive	16:9	SMPTE 274M
1080/25P	1125	1080	25	Progressive	16:9	SMPTE 274M
1080/30P *1	1125	1080	30	Progressive	16:9	SMPTE 274M
1080/50I	1125	1080	25	2:1 interlace	16:9	SMPTE 274M
1080/60I *1	1125	1080	30	2:1 interlace	16:9	SMPTE 274M/BTA S-001B
720/50P	750	720	50	Progressive	16:9	SMPTE 296M
720/60P *1	750	720	60	Progressive	16:9	SMPTE 296M

*1 Also supports frame rate 1/1.001.

Applicable DVI input signals

When a PC signal is input to the HDMI IN connector using a DVI conversion cable

Resolution	Dot clock (MHz)	fH (kHz)	fV (Hz)
720 × 400 70Hz	28.322	31.469	70.087
800 × 600 56Hz	36.000	35.156	56.250
800 × 600 60Hz	40.000	37.879	60.317
1024 × 768 60Hz	65.000	48.363	60.004
1280 × 768 60Hz	79.500	47.776	59.870

Note

The sides of the displayed picture may be invisible depending on the input signal.

When an optional input adaptor is connected, the unit is applicable to the following signal formats.

When BKM-341HS is connected

Input	
System	Signal standard
575/50I	SMPTE 259M
480/60I ^{*1}	SMPTE 259M
1080/24PsF ^{*1}	SMPTE 292M
1080/25PsF	SMPTE 292M
1080/24P ^{*1}	SMPTE 292M
1080/25P	SMPTE 292M
1080/30P ^{*1}	SMPTE 292M
1080/50I	SMPTE 292M
1080/60I ^{*1}	SMPTE 292M
720/50P	SMPTE 292M
720/60P ^{*1}	SMPTE 292M

*1 The frame rate is also compatible with 1/1.001.

Dimensions

Front

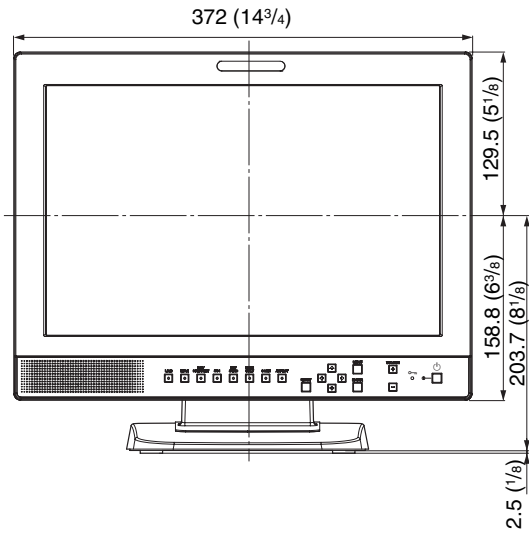

Rear

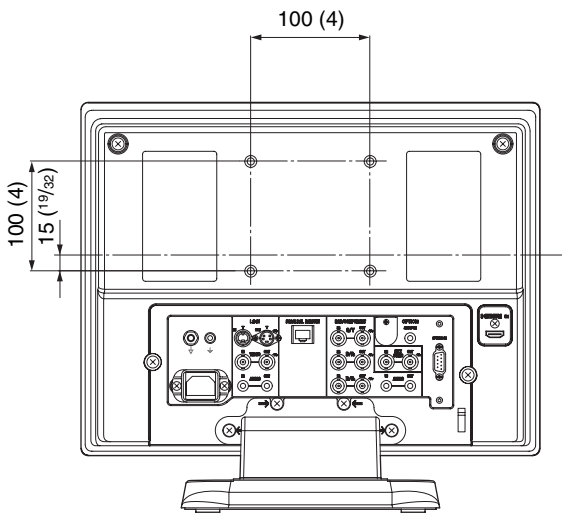

Side

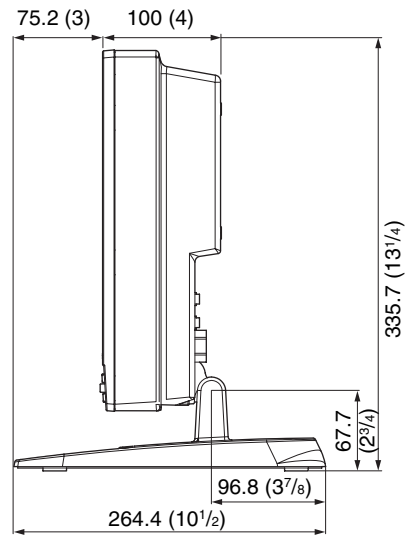

Bottom

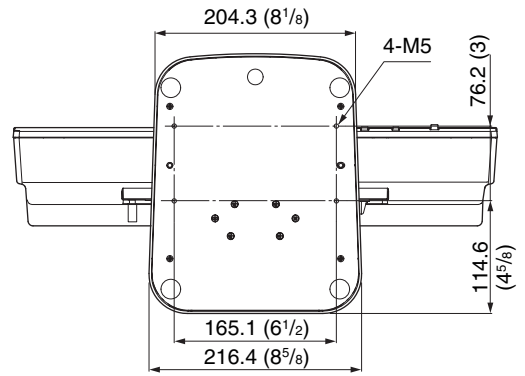

Unit: mm (inches)

Mass

Approx. 6.2 kg (13 lb 11 oz)



Sony Europe B.V.
Da Vincilaan 7-D1,
1930 Zaventem, Belgium



Sony Belgium, bijkantoor van
Sony Europe B.V.
Da Vincilaan 7-D1, 1930 Zaventem,
Belgium



Sony Corporation
1-7-1 Konan Minato-ku Tokyo,
108-0075 Japan