



GIMA

D 600

ROTARY SEALER

GIMA S.p.a.

Via Marconi, 1 – 20060 Gessate (MI) – Italy

Tel. 02.953854.1 – Fax 02.95381167

E-Mail: gima@gimaitaly.com

www.gimaitaly.com

Export dept.

Tel. ++39 02.953854209/221/225 – Fax ++39 02.95380056

E-Mail: export@gimaitaly.com

www.gimaitaly.com

**WARNING**

BEFORE USING THE MACHINE, READ CAREFULLY THIS MANUAL FOR A CORRECT USE IN ACCORDANCE WITH THE SAFE RULES.

CONTENTS

1 INTRODUCTION	
1.1 Use and safekeeping of this manual	page 1.1
1.2 Manufacturer's responsibility limits	page 1.1
1.3 Expected use	page 1.2
1.4 Technical characteristics	page 1.2
1.5 Transport and moving	page 1.2
1.6 Safety rules	page 1.3
1.7 To discard the machine	page 1.3
2 INSTRUCTIONS FOR USE	
2.1 Installation	page 2.1
2.2 Pouches introduction adjustment	page 2.1
2.3 Electrical wiring	page 2.1
2.4 Connecting to external devices	page 2.1
2.5 Switch on the machine	page 2.2
2.6 First employ	page 2.2
3 COMMAND PANEL	
3.1 Keys symbols	page 3.1
3.2 Operative visualizations	page 3.1
3.3 Operative settings	page 3.2
3.4 Machine alarms	page 3.5
3.5 Traceability	page 3.6
3.6 Block - Unblock display	page 3.6
4 CORRECT FUNCTIONING	
4.1 Sealing temperature	page 4.1
4.2 Sealing pressure	page 4.1
4.3 Sealing quality	page 4.1
4.4 Normal stop of the heat sealer	page 4.2
4.5 Emergency stop	page 4.2
4.6 Bag jamming	page 4.2
4.7 Pouches expulsion	page 4.4
5 MAINTENANCE	
5.1 Opening the machine	page 5.1
5.2 Main previous maintenance rules	page 5.1
5.3 Thermoelectrical protections	page 5.2
5.4 Replacement of the probe sealing jaws	page 5.3
5.5 Sealing pressure	page 5.3
5.6 Replacement of the transport belts	page 5.5
5.7 Replacement of the heating element	page 5.6
5.8 Replacement of the sealing jaws	page 5.8
5.9 Replacement of the line fuses	page 5.8
5.10 Replacement of the battery	page 5.9
5.11 Replacement of the motoreducer	page 5.10
5.12 Speed control	page 5.10
5.13 Replacement of the load cell	page 5.10
5.14 Infeed photocell calibration	page 5.11
6 ELECTRICAL DIAGRAMS	
6.1 Electrical diagram at 230 V	page 6.1
6.2 Electrical diagram at 115 V	page 6.2

7	WARRANTY TERMS AND SPARE PARTS	
	7.1 Warranty terms	page 7.1
	7.2 Spare parts order	page 7.1
8	PROBLEMS AND SOLUTIONS	
	8.1 Power supply	page 8.1
	8.2 Sealing	page 8.1
	8.3 Transport	page 8.1
	8.4 Alarms	page 8.2
9	ACCESSORIES	
	9.1 Working plane	page 9.1

CE DECLARATION OF CONFORMITY**SYMBOLS:**

warning meaning danger



warning meaning particular suggestion



warning meaning suggested maintenance

1. INTRODUCTION

1.1 Use and safekeeping of this manual

We thank you for the trust you put in us by buying our heat-sealer serie Gima D 600.

We are sure that, following correctly the instructions in this manual, you will find the quality of this product worth of appreciation.

For this reason, please give noted the present instructions to all people who are likely to use this machine.



WARNING

All people involved in the operation of this heat-sealer whether their task is production, maintenance or revision must read this instruction manual.

The instructions in this use and maintenance manual indicate, for this machine, the correct operations as intended in its design and technical specifications.

This booklet, provided with each heat-sealer is to be considered indispensable part of the equipment.

It must be safekept for continuos consultation for as long as the machine is operated.

This manual must be kept always close to the heat-sealer at hand of the operator for easy consultation.

In case of loss or damage, the customer can ask for a new manual of instructions, mentioning:

- model
- serial number
- manufacturing date

This information are written on the identification plate (pict.1.2), situated on the rear of the machine (pict.1.1).

The manufacturer reserves the right to improve or modify its products, without updating the items issued previously or their manuals.



pict.1.1

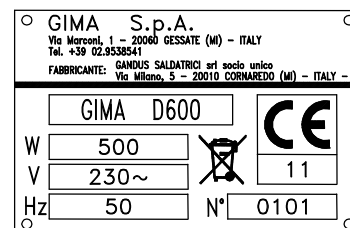

pict.1.2 (Id. plate n.1-pict.1.1)

- 1 Identification plate
- 2 Main power supply
- 3 Green general luminous switch

1.2 Manufacturer's responsibility limits

The sealer manufacturer is not responsible for direct or indirect damages derived from an incorrect use of the heat-sealer, specifically:

- employing this heat-sealer for other use than the one specified in this manual
- failure in the scheduled maintenance
- modify the heat sealer without the authorisation of the sealer manufacturer
- use of non original spare parts and not suitable for the model
- partial or total non compliance with the instructions
- exceptional events

1.3 Expected use

The *Gima D 600* is a continuous heat-sealer for closing hermetically sterilization pouches with surgical instruments and disposables made with multilayered envelopes like polyester / polyethylene, or other multilayered envelopes bags like paper/polyethylene, aluminium/polyethylene, etc.

The machine has been studied to be used only by an operator.



WARNING

The machine must not be used for other use than the one above mentioned, for which the machine has been designed and built.



WARNING

THE HEAT SEALER MUST NOT TO BE USED FOR THE SEALING OF SINGLE PLASTICS FILMS LIKE POLYETHYLENE, PLYPROPYLENE, PVC, AND SO ON.

1.4 Technical characteristics

- Sealing speed 6 m/min
- Electronic temperature control with 10°C - 200°C (±1%)
- Automatic stop of the heat-sealer if the sealing temperature has fallen down from setting value in a range ± 5°C.
- Electronic control of sealing force and speed
- Automatic stop of the machine if the sealing force and speed has fallen down from setting value (Fmin = 70N – Fmax = 102N; Smin = 5,0 m/min – Smax = 6,5 m/min)
- Autotest function
- Check internal temperature machine using thermal probe
- Clock and calendar with automatic update
- LC display with 2 lines for 8 characters
- Membrane keyboard with keys with buzzer
- Sealing width 12,5 mm multilines
- Free edge over the seal 0 - 30 mm
- Preadjusted sealing pressure
- 1 USB port for connection to a USB pendrive
- Power supply: 230-240V 50/60Hz or 100-115V 50/60Hz
- Power absorption 500 W
- Acoustic emission level 70 dB(A)
- Dimensions without accessories:
Width = 473 mm - Depth = 235 mm - Height = 181 mm
- Net weight 12,5 Kg
- As for DIN 58953 P. 7 specifications
- Built in accordance to the CE rules
- Environmental working conditions: Temperature: from 5°C to 40°C (from 41°F to 104°F)
Humidity relative: 30% - 95% (without condensation)

Gima S.p.a. reserves the right to modify the machines they construct without any obligation respect to those previously supplied

1.5 Transport and moving

We suggest to use the original packing during the transport.

We suggest to handle with care and to keep the packing, in dry environment, following the positioning symbols.



TO AVOID DAMAGE TO THE MACHINE, WHEN IT IS MOVED, IS FONDAMENTAL TO PRESERVE THE ORIGINAL PACKING.

Gima S.p.a. declines every responsibility for eventual damages to the machine, in case of shipments made without the original packing

To avoid damage when unpacking and for subsequent movements, act only below the basement.



The heat-sealer can be damaged if lifted or moved using other parts such as casing, conveyors, etc.

1.6 Safety rules

**WARNING**

THE OPERATOR MUST BE PROPERLY TRAINED AND HAVE FULL KNOWLEDGE OF THE CONTENTS OF THIS MANUAL



Before electrical wiring, check if the data on the identification plate (pict.1.2) corresponds to the local power supply

**WARNING**

CONNECT THE MACHINE ONLY TO A POWER SUPPLY WITH A PROTECTIVE DEVICE AGAINST OVERVOLTAGE AND DISPERSION TO EARTH, IN ACCORDANCE WITH THE SAFETY RULES AND CORRECTLY SIZED.

**WARNING**

UNPLUG THE MACHINE FROM THE MAIN POWER SUPPLY (N.2-PICT.1.1) BEFORE ANY MAINTENANCE OPERATION.



Do not operate with the heat-sealer if the safety panels are open or removed.

Here there are the most important suggestions for the safety and good maintenance of the machine:

- To ensure its good function, keep the heat-sealer clean.
- Before cleaning procedures on the heat-sealer machine unplug it (n.2-pict.1.1) from the main supply.
- Do not clean the heat-sealer with fluid or spray cleaners. Wipe the outside with a slightly moist cloth and clean the inside with compressed air.
- Never introduce in the sealing area anything but the bags to seal.
- Do not introduce in any opening of the heat-sealer machine metallic objects, to avoid electrical shocks.
- The heat-sealer must be used only indoor and in a dampness free environment.
Temperature: from 5°C to 40°C (from 41°F to 104°F)
Humidity relative: 30% - 95% (without condensation)
- Do not operate with the heat sealer in environments with risk of fire or explosion.
- Do not use the heat-sealer in packaging of inflammable, corrosive or explosive substances or in any case with dangerous products for the operator.
- Use only original spare parts.
- It is advisable to have the heat-sealer machine checked by a qualified technician every year.
- Do not change the set parameters while the heat-sealer is working.
- In case of replacement of the fuses check that they are at the same value

1.7 To discard the machine



According to the DIRECTIVE 2002/96/CE rules this symbol indicates that the device, when its work-life is ended, **must not be discarded as a urban waste.**

It can be given to a suitable discharging centers of the electronics and electric equipments or delivered to the dealer if you purchase an equivalent device.

The device owner is responsible for the delivery in to the discharging centers.

To get more informations about the discharging system, we suggest you to contact your local discharging waste service.

The right discharging of the disuse devices avoids such a negative consequences to the ambience and the human health.

2. INSTRUCTIONS FOR USE

2.1 Installation

The equipment can be used in any working environment that is dry and without excessive dust, according to the chap.1.6

Place the sealer on a work surface, leaving an enough large space in front of it for the bags to run over and on the sides the space for the introduction and exit of the bags from the machine.

Be sure that the heat sealer is at least 30 mm from the back wall in order to allow a perfect release of the heat produced inside and that on the sides there is the necessary space to allow a an easy loading and unloading of the bag that are being sealed.

2.2 Pouches introduction adjustment

To easily open the sealed medical pouches, it is necessary to leave a free edge over the seal.

According to the specific needs, it is possible to obtain a free edge from 0 to 30 mm. doing as follows:

- loosen the locking knob (n.1-pict.2.1) and move it:
 - on the right to reduce the free edge over the seal (min. 0 mm)
 - on the left to increase the free edge over the seal (max to 30 mm)
- at the end of this operation, lock the knob (n.1-pict.2.1)



1 Knob to infeed guide
2 Infeed guide

pict.2.1

2.3 Electrical wiring

Check that the main luminous switch (n1-pict.2.3) is switch off, in the " 0 " position (OFF).

Introduce the socket (n.3-pict.2.3) of the main power supply cable (n.4-pict.2.3) into the plug of the general switch (n.2-pict.2.3) before inserting the plug of the supply cable (n.4-pict.2.3) into the single phase socket.

Respecting the chapter 1.6, insert the plug of the main power supply (n.4-pict.2.3) into the single phase socket with protected earth from a magnetothermic switch, after checking that the data of the plate are the same of the power supply net.

2.4 Connecting to external devices

Through the **USB port** situated on the left side of the machine (see pict.2.2) you can connect the machine to an USB pendrive to save the traceability dates.

Enabling traceability (see par.3.3.2 - D), when we switch on the machine, the system checks the connection to the USB pendrive and the display shows, for a few seconds, the screen that follows here below:

**CHECK
PENDRIVE**

After diagnostics the screen automatically disappears.



Do not insert or disconnect the USB pendrive into the USB port when the machine is on

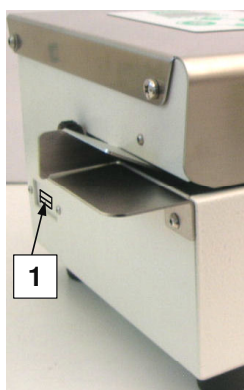

pict.2.2

1 USB port



pict.2.3

- 1 General luminous switch
- 2 Plug of the general switch
- 3 Socket of the supply cable
- 4 Power supply cable

2.5 Switch on the machine

Switch on the machine through the main GREEN luminous switch (n.1-pict.2.3) on position "I" (ON). The display lightens and the first screen that is displayed on the software version of the machine:

Firmware
2 . 0 0

After that the sealer does an autodiagnostic on the main components and evaluates the sealing parameters values. In case there is any alarm situation, the display will show the relative bad functioning (see chap.3); for ex. the low temperature alarm:

ERROR 12
PUSH SET

LOW
TEMPERAT

After this diagnostics, if there is no alarm, the display shows the measured temperature on sealing bars (T) and the set temperature (T_s):

$T = 160^{\circ}C$
 $T_s = 165^{\circ}C$

pict.2.4

After switching on the machine, the sealing bars begin their heating; *when the current and set temperature are at the same value, the sealers is ready to be used.*



The temperature stabilization takes some minutes.

2.6 First employ



WARNING:

- In order to avoid imperfect seals, bad functioning and/or machine stops, the operator always must introduce into the machine the pouch well stretched as shown on the pict.2.5.

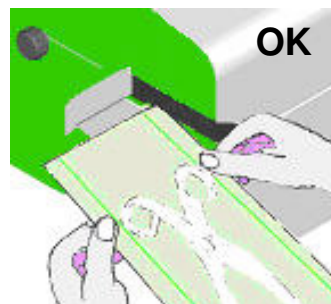
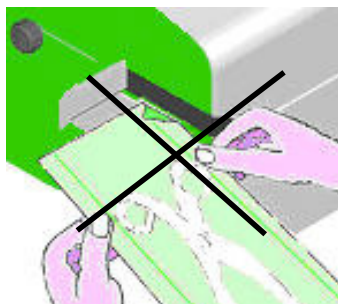

pict.2.5

- The DIN 58953 P7 rules requires the pouches can be filled up max until $\frac{3}{4}$ of their length
- Do not apply any kind of label and/or adhesive on the pouches near the sealing area
- For proper operation of the sealing machine, avoiding alarms and / or anomalies in the trace data storage, it is important that the pouches are introduced with a relative distance not less than 50 mm.

After switching on the machine (see par.2.5) and reaching the set sealing temperature, the machine is ready to do the first seal.

When introducing the first pouch into the sealing machine through the infeed guide the motor will automatically start running and the pouch will be feeded into the machine.

If the operator does not introduce any pouches into the sealing machine for approx. 10 sec, the gearmotor will stop automatically, in order to avoid useless consumes; it will start again running automatically when a new pouch is introduced.

3. CONTROL PANEL

In this section will be described the panel commands, which can be done by the operator to manage the working adjustments and the desired machine configuration.

The command panel allows the operator to visualize, set and/or modify the sealing temperature parameters.

Main menu visualized are two:

- VISUALISATION MENU : it contains the working views
- SETTING MENU : enables changes in the working settings

3.1 Keys symbols

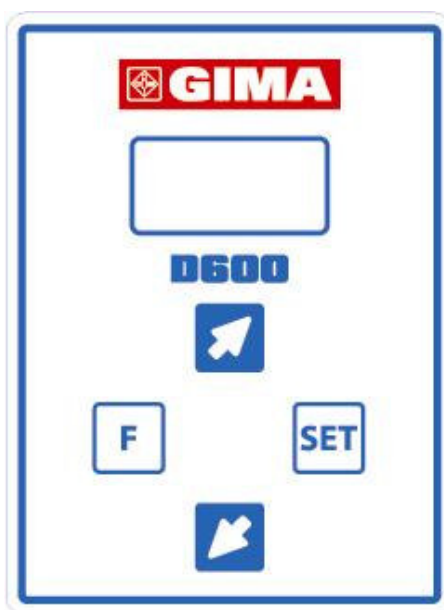

pict.3.1 (control panel)

The keyboard keys show the following functions:

- F** - Key with a double function: to shift from a view to the following or get out, without saving, from the selected section
- Set** - Key with a double function: to *enter the menu from settings or confirm the changes made*
- Up** - key to increase the selected date (number or character)
- Down** - key to decrease the selected date (number or character)

3.2 Operative visualizations

When starting the machine (see par.2.5) the display visualizes the firmware version and the software elaborates a diagnostic of the machine. Once completed, in case of no alarms or immediately after stopping the alarm, the view concerning the sealing temperature is visualized:

$$1) \quad \begin{array}{l} T = 175^{\circ}C \\ T_s = 185^{\circ}C \end{array}$$

where:

T is the real sealing temperature, **T_s** is the set la sealing temperature



If the **sealing temperature** is not between $(T_s + 5^{\circ}C)$ and $(T_s - 5^{\circ}C)$ the machine stops the transport of the pouches and the alarms is activated.

By pushing the key F the view concerning the strength and speed is shown

2)

F	= 1 0 0 , 0
S	= 5 , 9

where:

F is equal to the real sealing strength in Newton

V is equal to the real sealing speed in m/min



The reference sealing strength of the machine is **85 N**.
If the sealing strength is not between **70 N** and **102 N** the machine does not stop the transport of the pouches and the alarms starts.



The reference sealing speed of the machine is **6 m/min**.
If the sealing speed is not between **5,0m/min** and **6,5m/min** the machine stops the transport of the pouches and the alarm starts.

When pushing the key **F** the view concerning system date and hour is shown

3)

2 2 - 0 6 - 1 0
0 8 : 3 1 : 5 8

where:

2 2 - 0 6 - 1 0 corresponds to the system date, in the example in day-month-year

0 8 : 3 1 : 5 8 corresponds to the system hour in hour-minutes-seconds

When pushing the key **F** the view 1) concerning the temperatures.

3.3 Operating settings

Through the operating settings it is possible to set the working mode and all date concerning the pouch to be sealed.

3.3.1 Logic selection and changes of setting views

- By pushing the key **SET** from any of the 3 visualization views (1, 2, 3) the machine shows the first setting view (A). By pushing many times the key **F** a rotating menu is shown: it goes from one view to another.
- To come back to view 1) of temperature it is necessary to confirm, pushing the **SET** key, the view **EXIT** (point " I) " par.3.3.2) or it is enough do not execute any changes for 90 seconds long.
- To select and change a setting view, it is necessary to push the **SET key**, the date (number or character) will start blinking and it will be possible to change it.

Cases:

- If the date is selected from a set of predefined options (see **LANGUAGE** and **DATE**), by pushing **SET** the whole date will blink and it will be possible to visualize the following date by pushing the keys **Up** and/or **Down**; by pushing the **SET** key the choice will be confirmed and the date will stop blinking.
- If the date is a **numeric value** (see **TEMPERATURE** and **N° MACHINE**), by pushing **SET** the whole date will blink and it will be possible to increase it through the key **Up** or decrease through the key **Down**; by pushing then key **SET** change and date will be confirmed and the date will stop blinking.
- If the date is **alphanumeric** (see **OPERATOR** and **BATCH**), by pushing **SET** the first left character will blink and it will be possible to find the desired character by pushing keys **Up** and/or **Down**; to confirm the selected character it will be necessary to push key **SET**: it will stop blinking and the one on the right side will start blinking. Once finished the entering of the string, by pushing key **F** the system will show the following setting view.

NOTE

- **List alphanumeric settable characters:**

A B C D E F G H I J K L M N O P Q R S T U V W X Y Z
0 1 2 3 4 5 6 7 8 9 () : BLANK ` * + , - . / ! " # & < = > ? @

- To **cancel the whole string** it is necessary to push for 3 seconds key **SET** when the first left character is blinking
- To **cancel the single character** it is necessary to select the **BLANK** in the desired position
- By pushing keys **Up** and/or **Down** the characters will change quickly; by pushing once the key the change will be slow.
- By pushing key **F** with the blinking date no change will be done and the following view of the setting menu

3.3.2 Setting views sequence

Following the proposed views sequence; push key **F** to move from one view to the following.

A) Sealing temperature

```
SET TEMP
Ts = 150 °C
```

Sealing temperature in °C (**T s**); temperature value can be between 10°C and 200°C

B) Batch code

```
BATCH
AB01
```

The batch code is a string composed by max 8 alphanumeric characters

C) Operator's name

```
OPERATOR
SILVIA
```

Operator's name is a string composed by max 8 alphanumeric characters

D) Traceability setting (see par.3.5)

```
TRACE
NO
```

By pushing key **SET** the two following blinking views will appear:

```
TO
MODIFY
```

```
PUSH SET
```

By confirming through key **SET**, through keys **Up** and **Down** it will be possible to activate the traceability (**YES**) or deactivate (**NO**)

```
TRACE
YES
```

E) Machine ID

```
SEALER
N . 01
```

By pushing key **SET** the two following blinking views will appear:

```
TO
MODIFY
```

```
PUSH SET
```

By confirming through key **SET**, through keys **Up** and **Down** it will be possible to modify the machine ID

```
SEALER
N . 01
```

The machine ID number is between 01 and 99. This number is important when dealing with traceability (see par.3.5).

It is important that every machine is identified by a univocal number.

F) Language display

```
LANGUAGE
ENGLISH
```

Up to 6 languages can be set the display of the machine:
ITALIAN, ENGLISH, FRENCH,
GERMAN, SPANISH.

G) Date Format

```
DATE
dd-mm-yy
```

It is possible to set the date visualized by the display with 3 different sequences:
dd-mm-yy : days-months-years
yy-mm-dd : years-months-days
mm-dd-yy : months-days-years

H) System Date and hour (of the machine)

```
MODIFY
DATE / H
```

By pushing key **SET** the view of the **system date** will be visualized

```
DD-MM-YY
22-03-10
```

By pushing key **SET** the number of the day will start blinking; by keys **Up** and/or **Down** it will be possible to increase and/or decrease the number; by pushing key **SET** the date will be confirmed and the number of the month will start blinking; by following the same procedure described for days it will be possible to set both months and years. Once finished setting the year, the view of the **system hours** will appear

```
hh:mm:ss
23:04:30
```

By pushing key **SET** the number of the hour will start blinking; by keys **Up** and/or **Down** it will be possible to increase and/or decrease the number; by pushing key **SET** the date will be confirmed and the number of the minutes will start blinking; following the same procedure described for the hours it will be possible to set minutes and seconds. Once finished setting the seconds, the system will leave the setting

I) Leaving the settings menu

```
PUSH SET
EXIT
```

By pushing key **SET** the visualization view 1) of temperature will be proposed.
By pushing key **F** the view A) of the sealing temperature will be proposed and the cycle of the settings views will start again.

3.4 Machine alarms

When an alarm condition arises, the machine shows an acoustic signal (*beep*) and 2 blinking views are visualized, one after the other: the first with the alarm code (*for the codes list see Tab.1*) and with the operation that needs to be executed to stop the alarm, the second with a description of the aberration.

By pushing key **SET** the acoustic signal stops and the two blinking views disappear. In case one of the sealing parameters (temperature, strength, speed) is beyond the set limits, in visualization views 1) and/or 2) the relating number value will blink. If alarm is blocking (see Tab.1) the motor of the machine stops and does not start.

Example alarm views:

```
ERROR 32
PUSH SET
```

```
LOW
FORCE
```

after pushing key **SET**, in the visualization view 2) the strength value blinks

```
F = 75,0
S = 6,2
```

Tab.1 – ALARMS LIST

Cod.	Message	Blocking Alarm	Aberration Description	Action
1 1	HIGH TEMPERAT	YES	High Temperature, beyond the superior limit	Push SET per reset alarm e wait
1 2	LOW TEMPERAT	YES	Low Temperature, below the inferior limit	Push SET per reset alarm e wait
2 1	HIGH FORCE	YES	High Strength, beyond the superior limit	Push SET per reset alarm e check cause
2 2	LOW FORCE	YES	Low Strength, below the inferior limit	Push SET to reset alarm and check cause
3 1	HIGH SPEED	YES	High Speed, beyond the superior limit	Push SET for 3 sec to reset alarm and check cause
3 2	LOW SPEED	YES	Low Speed, below the inferior limit	Push SET for 3 sec per reset alarm e check cause
1 3	DAMAGED PROBE	YES	Probe bars temperature broken	Probe replacement
2 3	DAMAGED LOAD C.	YES	Load cell broken	Load cell replacement
1 4	INT TEMP FAULT	YES	Probe of the board damaged	Board replacement
2 4	CALIBR. LOAD C.	YES	Loss load cell calibration	Execute load cell calibration
1 5	CALIBR. PID	YES	Error heating parameters	Execute Auto tuning
7 1	SEALER VENTILAT	NO	Temperat. inside machine equal to 50°C (prealarm temperat. machine)	Reset alarm and check cause
7 2	INTERNAL TEMPERAT	YES	Overcoming temperature limit inside the machine (higher internal temp. equal to 60°C)	Reset alarm and check cause
4 1	SET LOSS	NO	Settings loss	Reset alarm and check cause and consequences
5 1	DATA/HOUR LOSS	NO	Low battery	Battery replacement
6 2	MISSING PENDRIVE	NO	No connection to pen drive USB	Reconnection to pen drive or traceability deactivation
Cod.	Message	Blocking Alarm	Aberration Description	Action

3.5 Traceability

By activating the traceability (see view D-Operating settings)



the firmware of the machine creates in the pen-drive USB connected to the machine a txt file with the following name:

Trace_N. machine.txt (for machine N. see view E- Operating settings)

For example if **machine N. is equal to 02**, the file name is **Trace_02.txt**

When a pouch is sealed, in the traceability file a data record is created with all the information concerning the pouch, including blocking alarms eventually arisen during the sealing of the pouch itself.

Every record of the file is composed by 11 columns separated by point and comma:

DATE	HOUR	MACHINE SOFTWARE VERSION	MACHINE ID	POUCH ID	SEALING TEMP.	SEALING SPEED	SEALING FORCE	BATCH	OPERAT.	ALARM CODE
YYYY/MM/DD (°)	hh.mm.ss (°)	4 alphanumeric characters	2 numeric characters	5 alphanumeric characters	3 numeric characters (in °C)	5 characters (in m/min)	5 characters (in N)	8 alphanumeric characters (°°)	8 alphanumeric characters (°°)	2 numeric characters (°°°)
2010/03/25	16.38.59	1.01	01	015GL	125	007.4	100.1		P1	00

Note

- (°) Y = year M = months D = days h = hours m = minutes s = seconds n = number
- (°°) if no operator is present, there are 8 characters Blank
- (°°°) alarm code:
 - if a blocking alarm linked to the pouch is present, the column “alarms” will show a 2 numbers code (see Tab.1)
 - if no alarm code is present, when the pouch leaves the machine, in the column “alarm” will be written 00
- The pouch ID code is composed by an alphanumeric code of 5 progressive alphanumeric characters.

Example: 00001– 00002 – 00003 - ... - 00009 – 0000A – 0000B - ... – 0000Z – 00011 - ... 0001Z - –00021

Example file traceability created by a machine identified by 01 and with version software 01

file name: **Trace_01.txt**

Date;Hour;vers. Soft;ID_sealer; Id_pouch;T (°C) ;V (m/min) ;F (N); Batch;Operator;Alarm
 2010/03/25;16.38.59;1.01;01;015GL;125;007.2;100.1; ;P1 ;00
 2010/03/25;16.39.40;1.01;01;015GM;124;007.4;100.2; ;P1 ;00
 2010/03/25;16.39.51;1.01;01;015GN;125;007.4;100.2; ;P1 ;00

3.6 Block – Unlock display

The display lock is a software option which prevents any change in the recorded parameters/data; with a locked display all views of all menu can be visualized but it is impossible to carry on any change.

To lock or unlock a display, it is necessary to push key **F** during the starting phase of the machine.

If the lock or unlock procedure has been correctly carried on, the system will show the initial view.

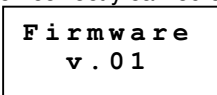

Immediately followed by the view:



or



If the system has been locked, once you enter the menu of operative settings, the system shows the view X) for 3-4 seconds before showing the initial view of the menu.

4. CORRECT FUNCTIONING

4.1 Sealing temperature

The sealing temperature value has to be set according to the thickness, the kind and the condition of the material to seal. Check that the set temperature corresponds to the suggested one by the bags manufacturing house.

Should this value be unknown, following a table containing indicative adjustment values of the heat sealer, according with the material used.

NORMAL STERILIZATION BAGS (*)

MATERIALS	PAPER/POLYPROPYLENE-POLYESTER	HEAT SEALABLE PAPER	TYVEK
FLAT POUCH	160° - 170° C	150° - 170° C	120°-130° C
GUSSETED POUCH	165° - 175° C	155° - 165° C	-----

(*)Gima S.p.a. takes no responsibility for the given data reliability.

For other materials or in case of troubles in finding the correct temperature, please send Gima S.p.a. a sampling of bags to allow comparative tests and calculate the relevant adjustment values.

To set a new sealing temperature value see par. 3.3.

Make some tests to check the correctness of the new temperature value.

4.2 Sealing pressure

The sealing pressure is already set by the manufacturer according with all materials in normal use.

In case you should need a pressure increase/decrease for special purposes see par.5.5.

4.2.1 Pressure control

Through the data showed on the display (see par.3.2) it is possible to check the correct sealing force, which, when the motor is off and with working temperature, must be close with the preset original value of the identification plate (85,0 N).

Beside, the pressure display shows the right behaviour range of the sealing pressure (-15N / +15N). If, when the sealer is on stand-by, the pressure value will close to one of the indicated limits, act as described in par. 5.5 to restore the original set value. If the modification exceeds the tolerance limits for the good functioning the machine shows the correspondent alarm on the display; check the cause.



Avoid using the sealer with pressure values that exceed the preset value of the identification plate, as the correspondent alarm could appear and the mechanics of the machine is exposed to a higher wear and tear.

4.3 Sealing quality

Aiming to obtain steady high quality seals, please follow these guidelines:

- during the sealing cycle the bag should not be submitted to any traction or moves;
- make sure that the part of the bag to be sealed is clean and dry;
- place carefully the mouth of the bag to be sealed inside the in-feed guide; during this operation, remove the air in excess;
- keep the mouth of the bag spread out until it is fully introduced in the sealing area of the machine; this will prevent from any damage to the sealing (see par. 2.6);
- never feed the pouches into the in-feed guide using a feeding speed higher than the machine transport speed;
- pouches feeding too much fast, can interfere with the in-feed photocell characteristic that might cause a transport stop;
- do not stop the sealer during the sealing, with the exception of emergency situations;
- should the bags be of small/medium size or with a light and not bulky contents, they can be conveyed by the machine over the support surface;

Should the bags be heavier and larger, the entrainment will be easier by using the slip rolls during the sealing (see par.9.1). The operator should in any case drive the bag during the sealing process.



Never introduce into the machine bags on which labels or adhesive tapes are applicated; this origins rests of material into the sealing tunnel, which causes the bags jam into the machine.



To obtain perfect seals and to make the work easier, the DIN 58953 rules state that the pouches must not to be filled more than the 3/4 of their length, letting always not less than 30 mm between the content and the internal edge of the seal.

4.4 Normal stop of the heat sealer

To switch off the heat sealer press the main GREEN luminous switch (n.3-pict.1.1) to the position "O" (off).



With the exception of emergency situations, do not stop the machine during the running of one or more pouches in the sealing area. This will avoid the overheating of the bags and the burning of material.

4.5 Emergency stop

In case of emergency, unplug the power cord (n.2-pict.1.1) from the machine. This action causes the complete disconnection of power supply and the consequent immediate stop of moving parts.

After solving any issue, to restart the sealer it is necessary to act on the main the GREEN light switch (n.3-pict.1.1) on "O" (off), reconnect the power cable and then run as described at par.2.5.

Since the temperature during the stop has come down, you will have to wait several minutes before the sealer will starts transport up to the temperature is reached.

4.6 Bag jamming

In case of a bag jamming into the machine, do as follows:



- **Swith off the sealer acting on the main switch (n.3-pict.1.1) and disconnect the power cable (n.2-pict.1.1).**
- **Do not rip the bag towards the external of the machine** to avoid formation of bag residuals, which could obstruct the sealing tunnel with a consequent jam of the following bag.



To avoid jamming follow the instructions of par.2.6 and par. 4.3

4.6.1 Bag jamming in the pressure and/or printing zone

A) SIMPLE BAG JAMMING

Do as follows



- **Swith off the sealer acting on the main switch (n.3-pict.1.1) and disconnect the power cable (n.2-pict.1.1).**
- Loosen the 2 screws (n.2-pict.4.1) and turn the upper cover (n.1-pict.4.1) until his total openness: the screws (n.2-pict.4.1) will be screwed to the frame machine (n.3-pict.4.1).



IF THE SEALER HAD BEEN OFF FROM FEW TIME, TO AVOID BURNS NOT TOUCH SEALBARS (pos. B-pict.4.3).

Ins

- At this point, slowly and smoothly pull the jammed envelope ert the reverse lever (n.2-fig.4.2), supplied together with the sealer, into the holes of the upper motor pulley (n.1-fig.4.2): see fig.4.2.
- **Rotate anti clockwise manually slowly the reverse lever (n.2-fig.4.2) till the pouch is complete free and out from the pressure wheel area.**



Pay particular attention to this operation because it could cause irreparable damage to the motor: if the movement of the belt was not prevented stress and go to step B).

- At this point, slowly and smoothly pull the jammed envelope

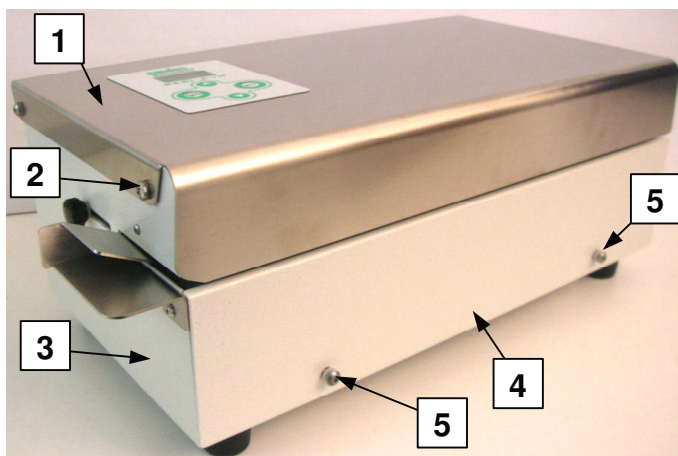

pict.4.1

- 1 Upper cover
- 2 Screw upper cover
- 3 Frame
- 4 Frontal cover
- 5 Screw frontal cover

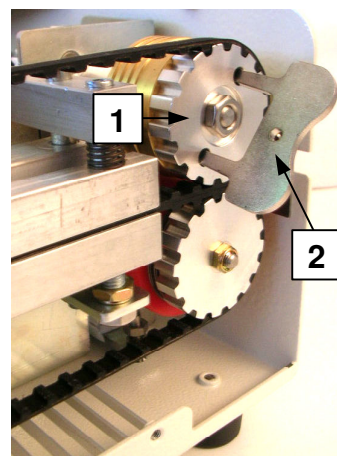

pict.4.2

- 1 Upper motor pulley
- 2 Reverse lever

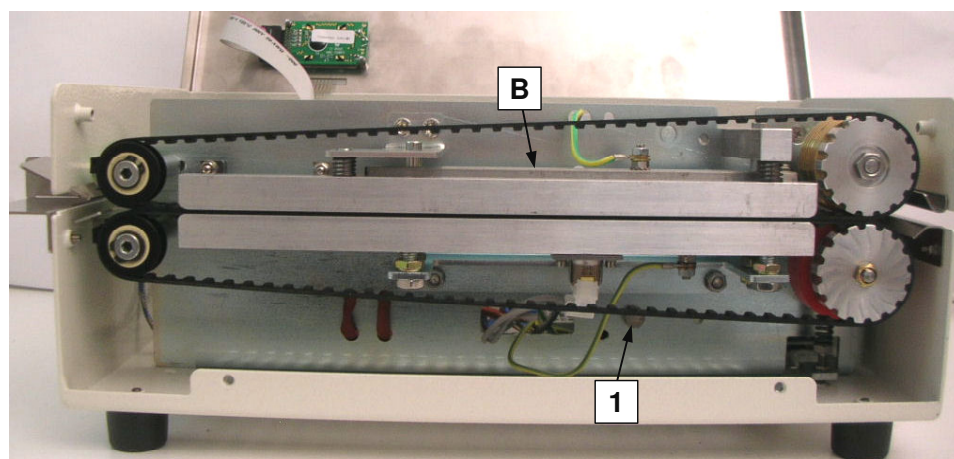

pict.4.3

- 1 Rotation screw motor reducer

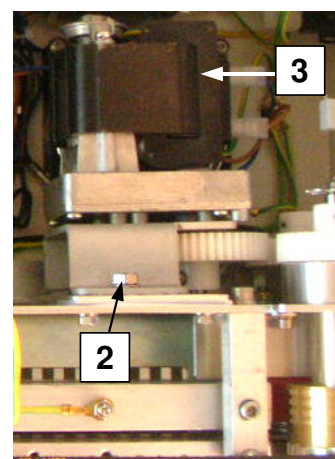

pict.4.4

- 2 Motor reducer
- 3 Upper locking screw motor reducer

B) COMPLEX BAG JAMMING

Do as follows:



- **Switch off the sealer acting on the main switch (n.3-pict.1.1) and disconnect the power cable (n.2-pict.1.1).**

- Loosen the 2 screws (n.2-pict.4.1) and turn the upper cover (n.1-pict.4.1) until his total openness: the screws (n.2-pict.4.1) will be screwed to the frame machine (n.3-pict.4.1).



IF THE SEALER HAD BEEN OFF FROM FEW TIME, TO AVOID BURNS NOT TOUCH SEALBARS (pos. B-pict.4.3).

- unscrew the 2 screws (n 5-pict.4.1) and open the frontal cover (n.4-pict.4.1) of the machine
- Disconnect the motor group (3-pict.4.4): turning clockwise it after loose the upper locking screw (n.2-pict.4.4) and the rotation screw (n.1-pict.4.3)
- Only if necessary, reduce sealing pressure (see par.4.2)
- Insert the reverse lever (n.2-fig.4.2), supplied together with the sealer, into the relaive holes in the upper motro pulley (n.1-fig.4.2): see fig.4.2.
- **Rotate anti clockwise manually slowly the reverse lever (n.2-fig.4.2) till the pouch is complete free and out from the pressure wheel area.**
- At this point, slowly and smoothly pull the jammed envelope

4.6.2 Restore of the machine for the correct functioning

After having let free the bag, before restarting the machine, do as follows:

- Be sure that there are no bag pieces into the sealing area
- Restore the sealing pressure if modified (see par. 5.5) and reconnect the motor to the transmission
- Close the upper cover (n.1-pict.4.1)and screwing the two screws (n.2-pict .4.1)
- Close the front cover (n.4-pict.4.1) and tighten fully grasped the 2 screws (n.5-pict.4.1)
- Plug the power cord (n.3-pict 1.1)

Now the machine is ready for the restarting.

4.7 Pouches expulsion

If there is activated an alarm that blocks the transport of the pouches into the machine, holding down the key **Up** the motor of the sealing machine will start for their expulsion; releasing the button the motor will stop.

5. MAINTENANCE



THE MAINTENANCE OF THE SEALER MUST BE MADE ONLY BY QUALIFIED TECHNICIANS, WHO MUST HAVE READ THE INSTRUCTIONS IN THIS MANUAL.



BEFORE ANY OPERATION, TURN OFF THE MACHINES WILL TAKE THE SWITCH (n.3-fig.1.1) BY POSITION **O** (OFF) AND DISCONNECT THE POWER CORD (n.2-pict.1.1).



IF THE SEALER HAD BEEN OFF TO LITTLE TIME, TO AVOID BURNS NOT TOUCH SEALBARS (n.2-pict.5.14).

5.1 Opening the machine



*Turning off the luminous green general switch (n.3-pict.1.1) in position “ **O** “ (switch off) and unplug the power cord form the main supply (n.2-pict.1.1)*

5.1.1 Upper cover

To access the internal components need to open the cover (n.1-pict.4.1):

- Loosen the 2 screws (n.2-pict.4.1) screws (n.2-pict.4.1) will be bolted to the machine frame (n.3-pict.4.1).
- Slowly turn the machine cover (n..1-pict.4.1) to its full opening

5.1.2 Front cover

To remove the front cover (n.4-pict.4.1) needs unscrew the 2 screws (n.5-pict.4.1) from the machine frame

5.2 Main previous maintenance rules

PRESSURE WHEEL



Check periodically the pressure wheel (n.1-pict.5.2) grooves (n.2-pict.5.2) in order to make sure that they are clean without any rest of pouches; on the contrary, clean them with a soft band or with a small plastic or wooden stick.



Do not use any metal objects, which could damage irreparably it.

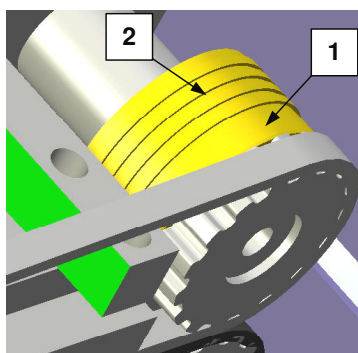

- 1 Pressure wheel
- 2 Pressure wheel grooves

pict.5.2

SEALING JAWS



Check periodically that the surfaces (in PTFE made) of the sealing jaws (n.1 and n.2-pict.5.3) in contact with the pouches are clean without any rest of pouches; on the contrary, clean them with a soft band or with a small plastic or wooden stick.



Do not use any metal objects, which could damage irreparably them

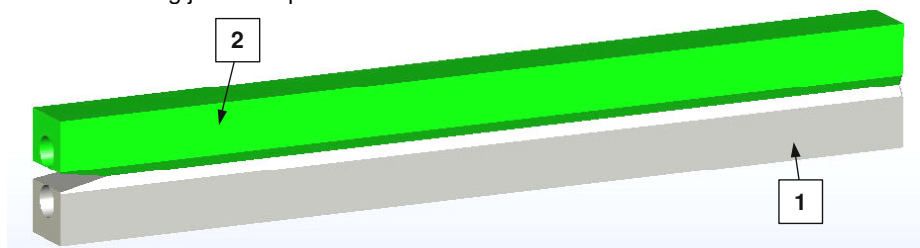

To access to the sealing jaws see par.5.8



pict.5.3

- 1 Lower sealing jaws
- 2 Upper sealing jaws

CONVEYOR BELTS

We suggest to put a thin layer of silicone grease on the conveyor belts, in order to facilitate the sliding in the guide rails and pulleys.

Keep the straps "dry" or non-lubricated, could cause friction and squeaks during operation of the machine.

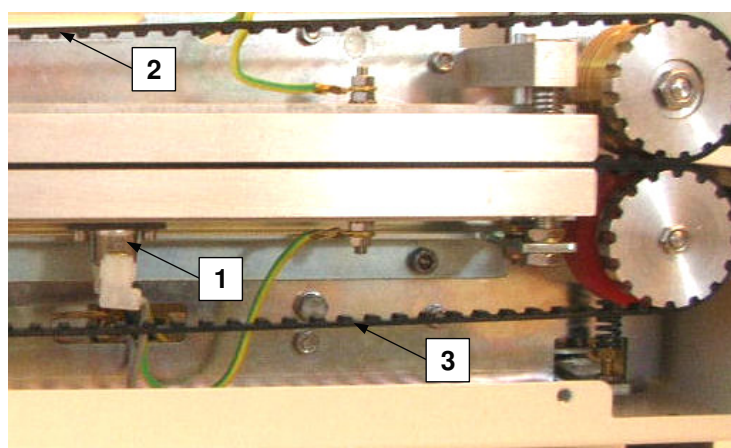

WARNING: Do not use too much grease in order to avoid to leave it on the pouches to be sealed. We suggest a quantity equivalent to a "grain of rice."

5.3 Thermoelectrical protections

- 1 Safety thermostat
- 2 Upper transport belt
- 3 Lower transport belt

pict.5.4

5.3.1 Thermic protection through thermostat (n.1-pict.5.4), which intervenes if there is a lack on the PLC temperature electronic control.

Its intervention will prevent from any danger of overheating, by stopping the machine.



If you do not switch off the machine through the main green luminous switch (n.3-pict.1.1), after the

stopping of the machine through the thermostat (n.1-pict.5.4), the sealer will restart as soon as the temperature lowers till a value under the intervention one.

In this case, stop the machine and contact the Manufacturer.

5.3.2 Thermal protection by software

Using a temperature probe, located on the board, is measured the temperature inside the machine; when it reaches 60 °C, the software stops the machine and stops the heating. The cause of the overheating could be caused by a fault in the cooling fan or when the machine is placed in a too hot environment.

5.4 Replacement of the sealing jaws temperature probe



The probe measuring the sealing jaws temperature is a thermocouple type J and does not need any maintenance

For the replacement:

1. open the upper cover of the machine, following the instructions par.5.1.
2. disconnect the cable of the probe (see cap.6-electrical diagram) from the main board
3. disengage the probe mount, turning the locknut (n.1-pict.5.6)
4. take out the sensible terminal of the probe (n.3-pict.5.6) from the lower sealing jaw
5. take out the cable (n.2-pict.5.6) from the locknut and remove the probe from the machine
6. replace it with a new one



during the mounting operation of the new probe strew the sensible terminal with conductor paste

7. close upper cover of the machine

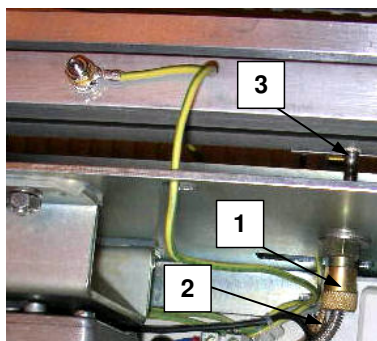

pict.5.6

- 1 Ring temperature probe
- 2 Wire temperature probe
- 3 Terminal temperature probe

5.5 Sealing pressure



With the machine on, using the data on the display (see par.3.1.4) you can check the value of the sealing force: in working conditions and with motor stopped, the strength of the seal must be close to the preset value equal to 85N.

5.5.1 Sealing pressure adjustment

The sealing pressure is already set by the manufacturer according with all materials in normal use.

Should you need a pressure increase/decrease for special purposes, turn the regulation nut do as follows:

1. open the frontal cover as described in par.5.1.
2. using a key, turn anticlockwise the nut (n.3-pict.5.7) in order to make it free to rotate.
3. using a key, turn the screw head pressure (n.2-pict.5.7):

- Rotating clockwise pressure decrease
 - Rotating clockwise pressure increase
4. Keep the head screw (n.2-pict.5.7) stop, turn clockwise the nut (n.3-pict.5.7) and lock it
 5. Close the frontal cover of the machine



Any pressure increase must be limited to not damage the counter wheel ring (n.3-pict.5.7) and the motor .

5.5.2 Replacement pressure spring

If you need to replace the pressure spring (n.1-pict.5.7), do as follows:

- 1) open the frontal cover as described in par.5.1.
- 2) using a key, turn anticlockwise the nut (n.2-pict.5.7) in order to make it free to rotate.
- 3) using a key, rotate clockwise the screw head pressure (n.3-pict.5.7) in order to make it free the spring pressure (n.1-pict.5.7)



Be careful not to damage the load cell

- 4) remove the spring pressure and replace it by new.
- 5) using a key, turn the screw pressure (n.2-pict.5.7) to obtain a sealing force (see par.3.1.4) between 85N and 88N.
- 6) lock nut (n.3-pict.5.7) and close the frontal cover.



The sealing force must take a value between 85N and 88N.

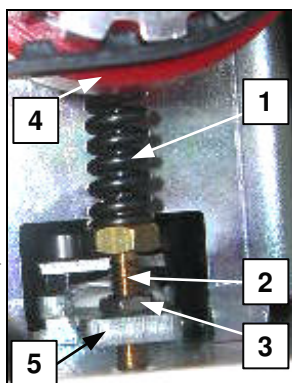
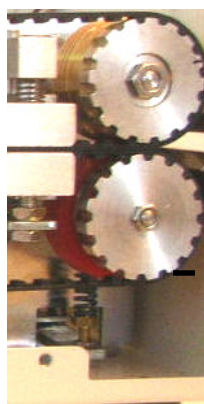

- 1 Pressure spring
- 2 Screw pressure
- 3 Nut
- 4 Counter wheel
- 5 Load cell

pict.5.7

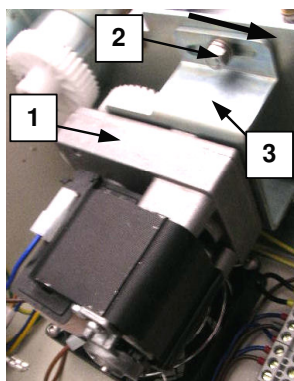

pict.5.8

- 1 Motoreducer
- 2 Upper screw Locking motoreducer
- 3 Support motoreducer

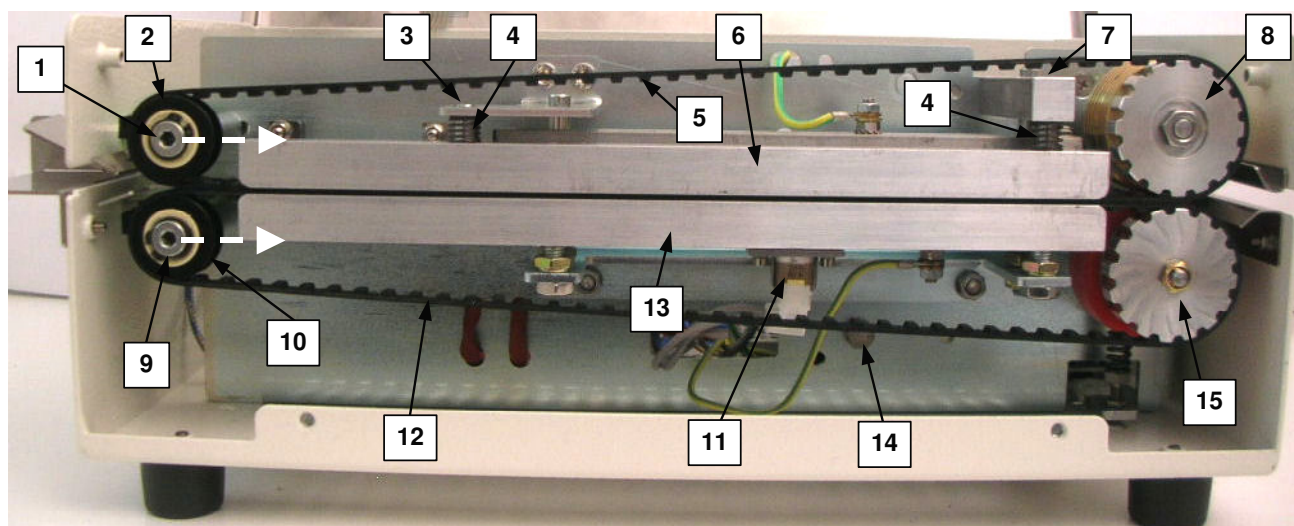

pict.5.9

- | | | |
|------------------------|-----------------------|------------------------------------|
| 1 Pin upper pulley | 6 Upper transport bar | 11 Safety thermostat |
| 2 Upper pulley | 7 Pin upper pulley | 12 Lower transport belt |
| 3 Plug upper bar | 8 Upper motor pulley | 13 Lower transport bar |
| 4 Transport bar spring | 9 Pin lower pulley | 14 Lower screw locking motoreducer |
| 5 Upper transport belt | 10 Lower pulley | 15 Lower motor pulley |

5.6 Replacement of the transport belts



*The transport belts do not need any previous maintenance.
Their replacement is suggested only in case the teeth or the cover, which are in contact with the pouches, are worn out.*

Act as follows:

- open the upper cover and the frontal cover following the instructions to the par.5.1
- discharge the sealing pressure (see par.5.5)
- After loosening the upper screw lock (n.2-pict.5.8) and the screw rotation (n.14-pict.5.9), disconnect the motoreducer unit (n.1-pict.5.8) by rotating in the direction of the arrow the arrow fig.5.8
- disengage the motor reducer (n.1-pict.5.9) turning it anticlockwise (see arrow in pict.5.7)

A. TAKE OUT THE UPPER BELT TRASPORT

- remove the upper transport jaw (n.6-pict.5.9) unscrewing the two guide pins (n.3-pict.5.9 and n.7-pict.5.9)



Be careful not to loose the spring pressure (n.4-pict.5.9)

- unscrewing the lock screw (n.1-pict.5.9) of the *upper pulley pivot*.
- move the upper conduct pulley (n.2-pict.5.9), according to the arrow direction of pict.5.9
- take out the upper transport belt (n.5-pict.5.9) from the upper motor pulley (n.8-pict.5.9) with a low pressure towards the outside

B. TAKE OUT THE LOWER BELT TRASPORT

- unscrewing the lock screw (n.9-pict.5.9) of the upper conduct pulley (n.10-pict.5.9)
- move the conduct motor pulley (n.10-pict.5.9), according to the arrow direction of pict.5.9
- take out the lower transport belt (n.12-pict.5.9) from the lower motor pulley (n.15-pict.5.9) with a low pressure towards outside

C. How to mount the lower trasport belt

- Insert the lower transport belt (n.12-pict.5.9) first of all on the lower motor pulley than on the lower conduct pulley (n.10-pict.5.9)

- Stretch the lower transport belt (n.10-pict.5.9) and fixing the pivot lower conduct pulley (n.9-pict.5.9) with the relative screw



Verify the correct insertion of the lower belt in the pulley by turning slowly in the lower motor pulley



Correct tensioning when the belt has small vertical oscillations during the transport

D. How to mount the upper transport belt

- Insert the upper transport belt (n.5-pict.5.9) first of all on the upper motor pulley (n.2-pict.5.9), then on the upper conduct pulley (n.2-pict.5.9)
- Stretch the upper transport belt and fixing the lower pivot lower conduct pulley (n.1-pict.5.9) with the relative screw



Correct tensioning when the belt has small vertical oscillations during the transport



Verify the correct upper belt fitting up on the pulleys, turning the upper motor pulley

E. RESTORE THE MACHINE

- remount the upper transport jaw (n.6-pict.5.9) screwing the two guide pins (n.3 and n.7-pict.5.9)
- restore the correct sealing pressure (see par.5.5)
- reposition in its correct way the motoreducer (n.1-pict.5.8)
- remount the front cover and the upper cover.

5.7 Replacement of the heating element

Act as follows:

- open the upper cover and the frontal cover following the instructions as described in par.5.1

1. EXTRACTION OF THE UPPER SEALING JAW

- remove the upper transport jaw (n.6-pict.5.9) unscrewing the two guide pins (n.3-pict.5.9 and n.7-pict.5.9)



Be careful not to loose the two pressure springs (n.4-pict.5.9)

- disconnect the two cable edges of the upper heating element from their terminal bloc (see electric scheme cap.6)
- unscrew the locknut of the ground cable (n.2-pict.5.12)
- unscrew the nut n.3-pict.5.12)
- unscrew the no-head screw (n.1-pict.5.12) of the heating element
- unscrew the two guide pins (n.1 and n.4-pict.5.14)
- remove from the machine the assembly jaws+heating element (n.2-pict.5.14)

2. REPLACEMENT OF THE UPPER HEATING ELEMENT

- insert the new heating element in the upper sealing jaw in such a way that it is completely contained into the jaw seat.



During the remounting operations do not exceed with the tightening, especially in the lock no-head screw of the heating element

- remount everything by following the reverse procedure

3. REPLACEMENT OF THE LOWER HEATING ELEMENT

- Extract the upper sealing jaw (see point 1)
- disengage the probe mount, turning the locknut (n.3-pict.5.14), and remove the probe

- disconnect the cable edges of the heating elements from their terminal bloc
- disconnect the two terminal (n.3-pict.5.113) edge of the safety thermostat (n.4-pict.5.10)
- unscrew the locknut (n.2-pict.5.13) of the lower ground cable (n.4-pict.5.13)
- unscrew the nut n.1-pict.5.13
- unscrew the no-head screw (n.3-pict.5.13) of the heating element
- unscrew the lower locknuts (n.2-pict.5.10) securing the lower sealing jaw the traverse of the machine and remove the assembly heating element+jaw



Never loosen the register nuts (n.3-pict.5.10)

- insert the new heating element in the sealing jaw in such a way that it is completely contained into the jaw seat and lock it with the the no-head screw (n.3-pict.5.12)



During the remounting operations do not exceed with the tightening, especially in the lock no-head screw of the heating element

- remount everything by following the reverse procedure

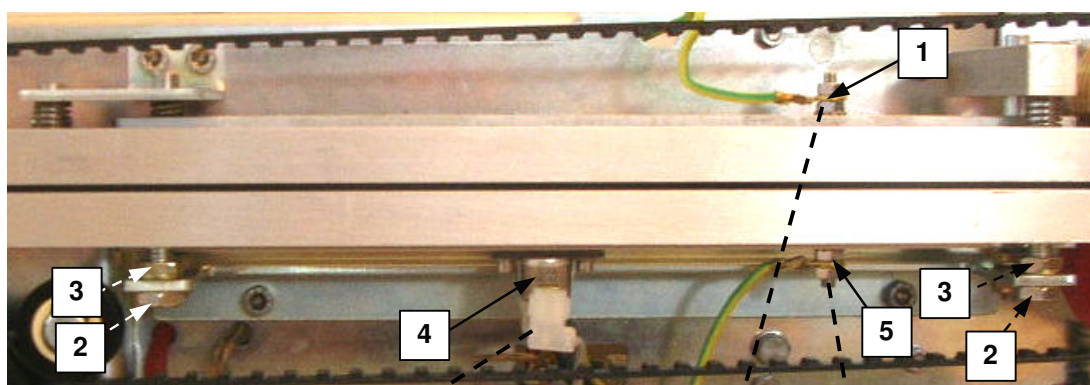
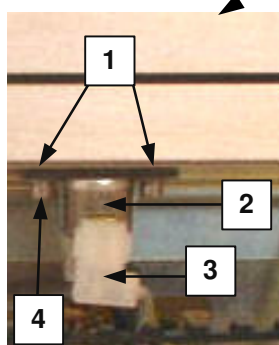

fig.5.10

- 1 Screw of the upper ground cable
2 Lower locknut
3 Upper adjusting nut

- 4 Safety thermostat
5 Screw of the lower ground cable



pict.5.11 (pos.4-pict.5.10)

- 1 Spacer washers
2 Safety thermostat
3 Terminals thermostat cable
4 Screw lock thermostat

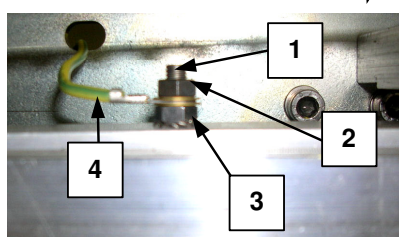

pict.5.12 (pos.1-pict.5.10)

- 1 No-head screw
2 Nut
3 Nut
4 Upper ground cable

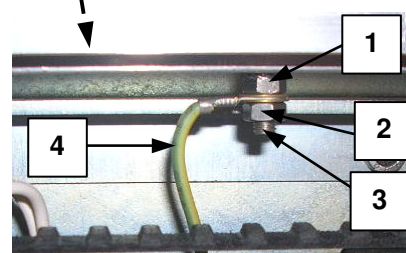

pict.5.13 (pos.5-pict.5.10)

- 1 Nut
2 Nut
3 No-head
4 Lower ground cable

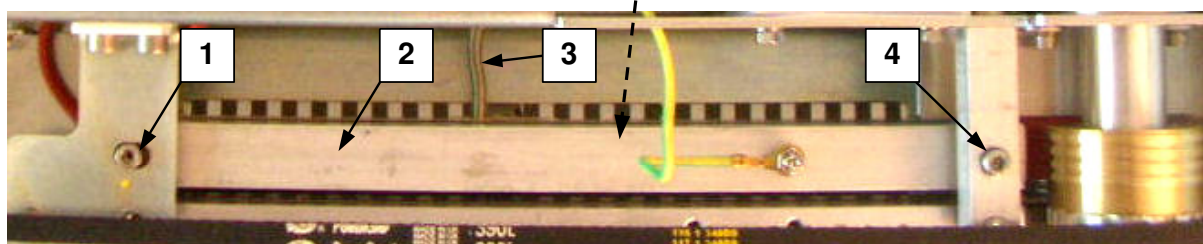
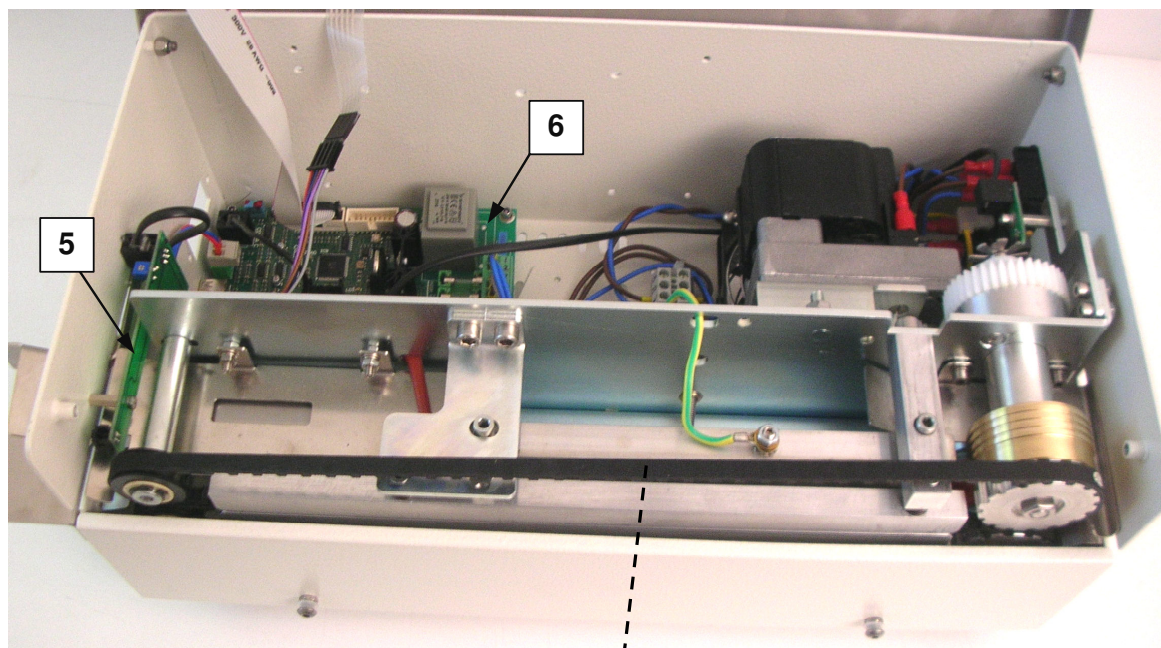

pict.5.14

- 1 Pin of the upper sealing jaw
- 2 upper sealing jaw
- 3 Cable of the temperature probe

- 4 Pin of the upper sealing jaw
- 5 Infeed photocell
- 6 Main board

5.8 Replacement of the sealing jaws



The replacement of the sealing jaws is necessary only in case of worn out of the surface coating.

For the replacement procedure act as described in the par.5.7

- Do the same operations described in paragraph 5.7 without disconnecting the cables of the the terminal heating element.
- Remove the protection thermostat (n.4-pict.5.10) from the lower sealing jaw.



When you remount the thermostat, be sure to remount the spacer washers (n.1-pict.5.1) placed between the plate and the lower sealing jaw.

5.9 Replacement of the line fuses



Turning off the luminous green general switch (n.3-pict.1.1) and unplug it form the main supply (n.2-pict.1.1)

- open the fuse box drawer (n.1-pict.5.15) as shown
- pull out the fuses to be replaced (n.2-pict.5.15), eventually helping you with a suitable screw-driver
- insert the new fuses and close the fuse box drawer

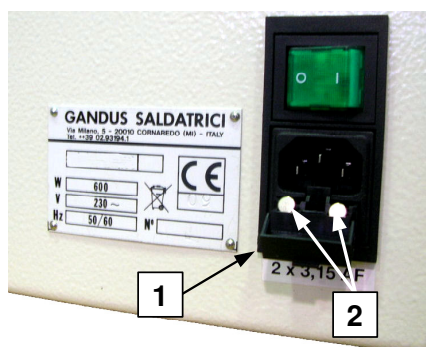

- 1 Line fuses
- 2 Fuse box drawer

fig.5.15

5.10 Replacement of the battery

When the display shows the relative message at the end of the BATTERY TEST, it is necessary to replace it.



The keeping data battery has to be replaced with the machine switched off. This is important in order to avoid any damages on the main board (pict. 5.18)

Do as follows:

- open the upper cover and the front cover following as described in par.5.1
- remove the battery
- insert the new battery keeping the symbol “+” on the left side (see pict.5.16)
- switch on the machine and wait for the positive result of the BATTERY TEST
- set current date and time (see par. 3.3)

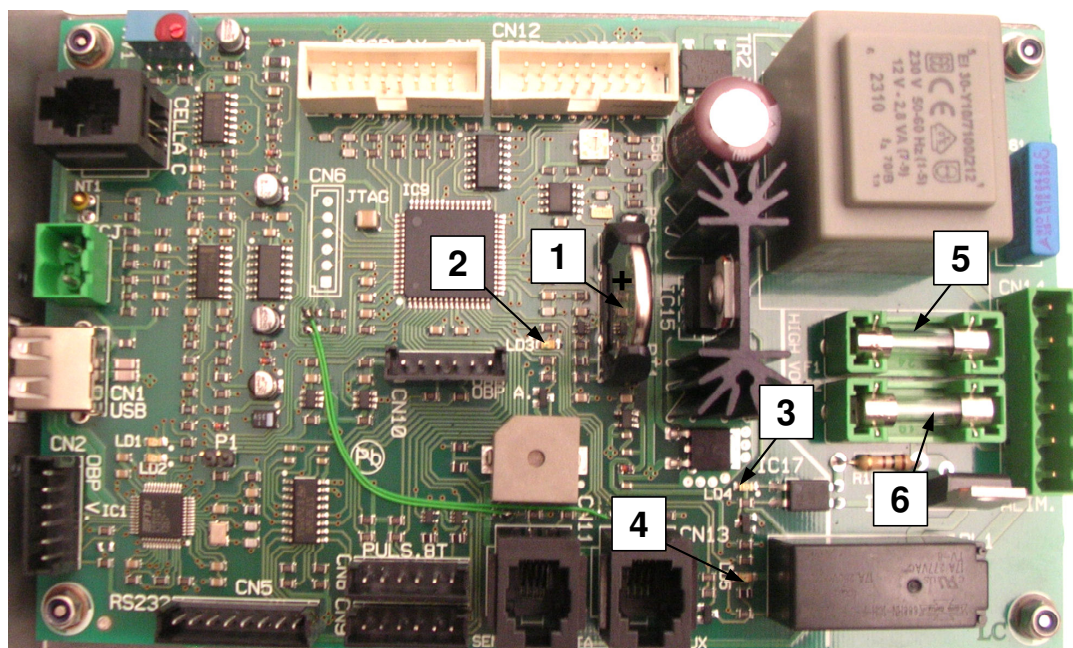

pict. 5.16

- | | |
|------------------------|---|
| 1 Battery | 4 Motor led |
| 2 Infeed photocell led | 5 Comon fuse for heating elements and motor |
| 3 Heating elements led | 6 Heating elements fuse |

5.11 Replacement of the motoreducer

If you need to replace the motoreducer (n.1-pict.5.8) do as following:

- open the upper cover and the frontal cover of the machine as described in par.5.1
- disconnect the 2 motor power cable terminals and the motor ground cable terminal
- Unscrew the lower screw (n.14-pict.5.9) and the upper screw (n.2-pict.5.8) locking the motor
- Remove the motor unit (n.1-pict.5.8) with its support (n.3-fig.5.8) from the machine and replace everything with a new
- Put the new motor unit-motor support paying attention to the engaging between the teeth of gears
- Connect the terminals of the motor power cables and those of the ground cable
- Close the upper cover and the frontal cover of the machine

5.12 Speed control

The speed control unit is realized with the photocell n.1-pict.5.17 reading the rotation of the camb n.2-pict.5.17

The low speed error message appears if the photocell n.1-fig.5.17 has disconnected, faulty or not properly positioned, then placed not perpendicular and at a distance of approximately 1-2 mm from the cam.

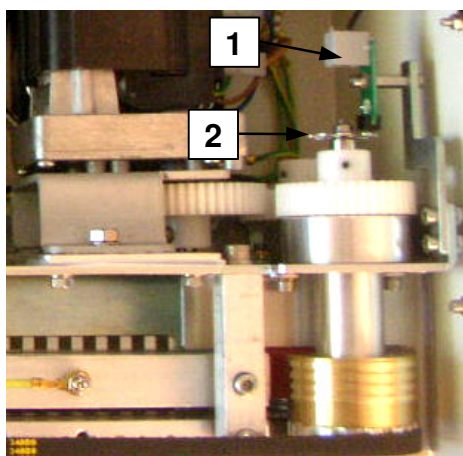

pict. 5.17

- 1 speed control photocell
- 2 speed cam

5.13 Replacement of the load cell

If you need to replace the load cell (n.5-pict.5.19) do as following:

- open front cover of the machine as described in par.5.1
- using a key, turn anticlockwise the nut (n.2-pict.5.19) in order to make it free to rotate.
- using a key, rotate clockwise the screw head pressure (n.3-pict.5.19) in order to make free the spring pressure (n.1-pict.5.19)
- remove the spring pressure (n.1-pict.5.19)
- unscrew the screw pressure (n.2-pict.5.19) and remove it from the load cell (n.5-pict.5.19)

- unscrew the two nuts (n.1-pict.5.18) at the bottom of the machine frame; these nuts lock the load cell at the frame.

- open the upper cover and the frontal cover of the machine as described in par.5.1
- unscrew the lower screw (n.14-pict.5.9) and the upper screw (n.2-pict.5.8) locking the motor
- push the motor unit (n.1 and n.3-pict.5.8) in order to have access to the load cell (n.5-pict.5.7)

- remove the faulty load cell with spacer, the two screws and two nuts (n.4-pict.5.19)
- remove from the load cell fails the spacer, the two screws and two nuts attached to it (n.4-pict.5.19) and mount

them in the new one

- put the new load cell
- put the new motor unit-motor support paying attention to the engaging between the teeth of gears
- put the pressure screw (n.2-pict.5.19) and the spring pressure (n.1-pict.5.19) in order to obtain a sealing force (see par.3.1.4) between **85N** and **88N**.
- close the upper cover and the frontal cover of the machine

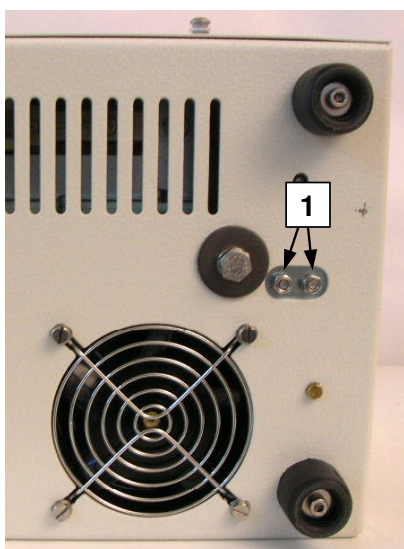

pict.5.18

1 Nut for load cell

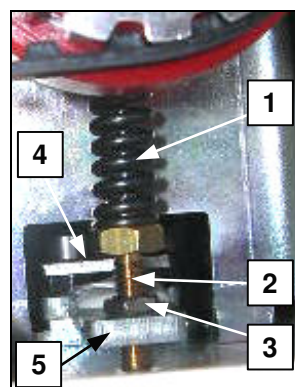

pict.5.19

- 1 Pressure spring
- 2 Screw pressure
- 3 Nut
- 4 Spacer, screws and nuts for load cell
- 5 Load cell

5.14 Infeed photocell calibration

The motor of the sealer should be running even when no pouches are inserted into or, on the contrary, should not start; in these cases it is necessary to do the infeed photocell calibration (n.5-fig.5.14).

To do this calibration, proceed as follows:

- with the closed cover, during the sealer switch on phase, press for approx. 3 seconds the key **Down**: the display will show alternatively the two here-below flashing screens:

PUT
POUCH

PUSH
329 SET

where 329 is the current value of the photocell reading.



If the reading value is at 0 the photocell should be disconnected or lacked

- insert a pouch in the infeed guide and press the key **Set**: the display will show alternatively the two here-below flashing screens:

REMOVE
POUCH

PUSH
39 SET



When the photocell reads the presence of the pouch, the current reading value has to decrease (see the ex. from 329 to 39)

- take out the pouch and press the key **Set**: comparirà for approx. 5 seconds the screen will confirm the correctness of this operation and the display will show the numerical data corresponding to the average of the 2 photocell readings (with and without pouch) :

FTC OK
SENS = 184



For a correct functioning, the visualized data has to be more than 90

After approx. 5 seconds the sealer will start automatically the switch on procedure.

6. ELECTRIC SCHEME

6.1 Electric scheme 230Vac - 50/60Hz

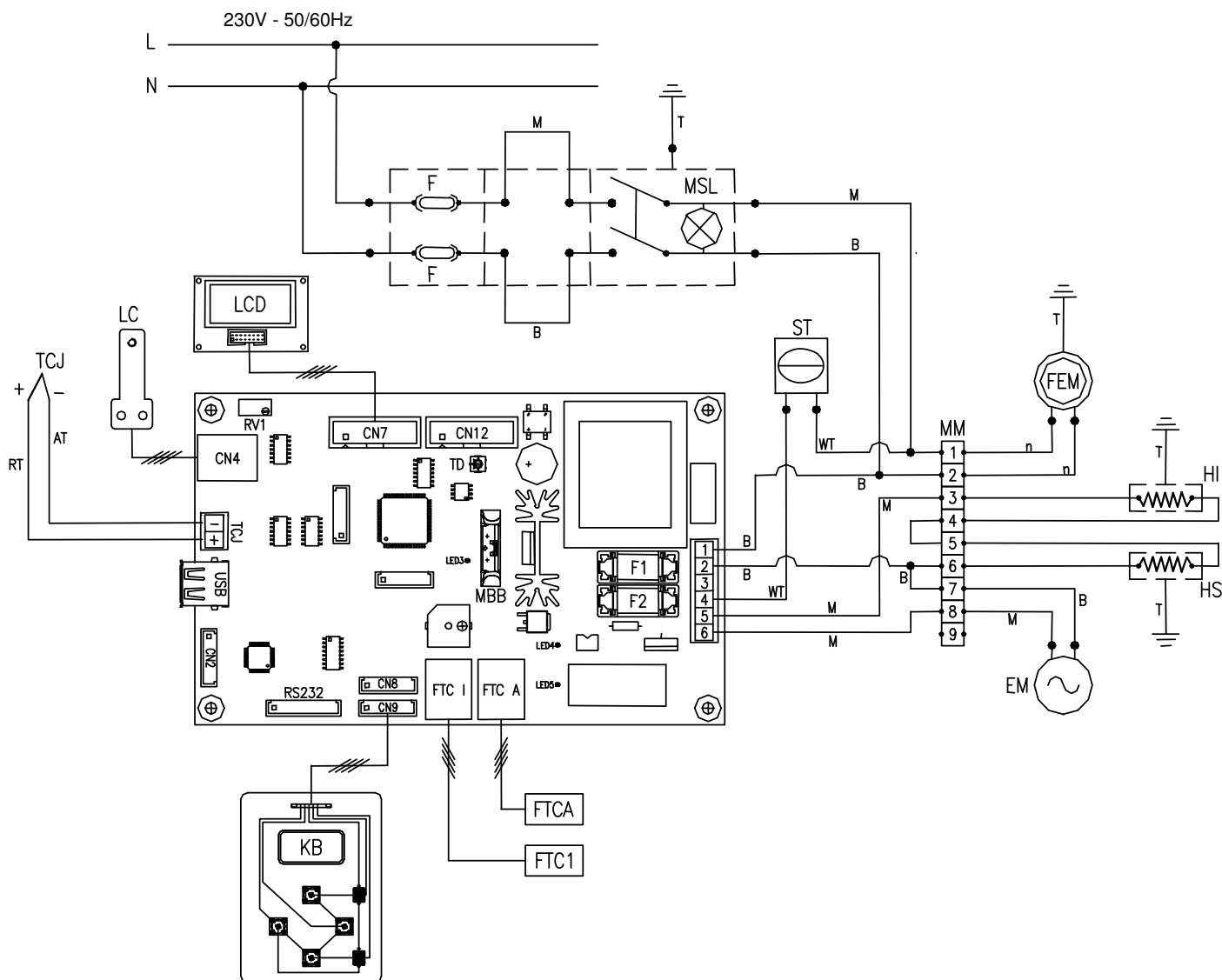

AT	blue color thermocouple cable	LED4	Led heating element on
B	blue color cable	LED5	Led motor on
EM	motoreducer 230Vac	MB	main board
F	line fuses 3,15AF	MBB	battery main board
FEM	fan	MM	terminal board
FTC1	infeed photocell	MS	main switch
FTCA	speed photocell	MSL	main switch lamp
F1	fuse common actuators - T 5A	n	black color cable
F2	heating element fuse - T 3,15A	R	red color cable
HI	lower heating element 200W 110Vac	RT	red color cable thermocouple cable
HS	upper heating element 200W 110Vac	ST	safety thermostat
KB	command keyboard	T	ground cable
LC	load cell	TCJ	thermocouple J
LCD	LCD display board	TD	trimmer contrast display
LED3	Led infeed photocell on	WT	white color cable for safety thermostat

7. WARRANTY TERMS AND SPARE PARTS

7.1 Warranty terms

The heat-sealer are built to perform and they are guaranteed for 12 months after delivery. For the duration of the warranty, the manufacturer will replace parts or elements that, under his examination, should result defective for factory construction, error or faulty materials, but not the parts presenting normal wear, demonstrating incorrect use of the equipments or tampering.

Are excluded from this warranty the materials subject to normal wear, such as protective cloths, belts, straps rubber, resistors, etc.

This warranty is accepted in our offices, for equipment delivered to us free of charges, that shall be returned on ex-factory basis.

This warranty is void if the heat-sealer has been altered or has been fitted with unauthorized spare parts.

The warranty is also void if the customer does not comply with the form of payment established even once.

For the parts not manufactured by *Gima S.p.a.*, the warranty is conditioned by the one provided by the supplier.

For the duration of the warranty too, if the heat-sealer is subject to any intervention by our personnel outside our seat, the manufacturer will charge work-hour and transportation fee.

Gima S.p.a. declines every responsibility for eventual damages to the machine, in case of deliveries made without the original packing

7.2 Spare parts ordering

Always mention:

1. Serial number of the sealing machine
2. Quantity of the spare part you need
3. Position and table number identifying the requested spare part

8. PROBLEMS & SOLUTIONS

Here below you will find the possible troubles that can occur during the normal functioning of the sealer and for each one the possible solution.

In case you cannot solve the troubles with these instructions, put in contact with our dealer or with us directly.

8.1 Power supply

- The sealer does not function and the main green luminous switch (n.3-pict.1.1) does not light.
 - a) The fuses (n.2-pict.5.15) are burnt out: replace them with new one of the same type and class
 *If they burn out again after the replacement, put in contact with the seller or manufacturer because it could be a short circuit of the electrical system in the machine*
 - b) The power cord (n.2-pict.1.1) is not connected or interrupted: connect it again or replace it
- The sealer does not function and the main green luminous switch (n°1 pict. 1.1) lights.
 - a) Verify that the main board is correctly powered: the led has to be lighted. If it not happens, check the fuses on the board (see electrical diagram)
 - b) The safety thermostat has intervened: turning the luminous green general switch (n.3-pict.1.1) and unplug it from the main supply (n.2-pict.1.1)

8.2 Sealing

- The seal has some defects alongside the edges:
 - a) verify if the set sealing temperature value is suitable for the pouches to be sealed (see table par 4.1)
 - b) wait for the stabilization of the sealing jaws temperature especially if you made a new temperature adjustment
- The seal, even if done at the correct temperature, is not strong:

follow the instructions par. 4.3
- The sealing jaws temperature remains at the ambience temperature:
 - a) The common fuse actuators (F1) or heating element fuse (F2) (see cap.6) is interrupted: replace with same type and class
 - b) Verify that the electrical heating element is not broken: broken or disconnected
- The seal, at the beginning, shows a shrink of the plastic material:
 - a) check that the sealing path is free and clean. Verify that the pouch, if it is heavy or voluminous, does not find any obstacle in its in-feed
 - b) verify that the internal or external pouch edges are clean and dry, before doing the seal
 - c) check that the sealing jaws and the counter pressure are clean (see par.5.2)
 - d) check if the sealing jaws are clean

8.3 Transport

- The in-feed motor does not stop automatically after 10 sec. from the last sealed pouch:
 - a) check the vertical alignment between the in-feed photocell transmitters (n.5-pict.5.14) and if they are clean. The alignment is correct if the led lights only when a pouch is inserted
 - b) check that the linking phone cord is correctly inserted into the in-feed photocell plug and in the main board
 - c) the in-feed area of the machine is exposed to excessive brightness of the environment; calibrate the in-feed photocell.

- The in-feed motor does not transport:
 - a) The fuse (F1) (see cap.6) is damaged, replace it with same type and class
 - b) the motor gears are worn out: replace the motor reducer
 - c) check that the power linking “faston” to the motor reducer are correctly inserted
 - d) verify that the led switches on (par.5.12) when a pouch is in-feeded; on the contrary put in contact with your dealer or directly with Gima S.p.a.

- Pouches jam. at the exit:
 - a) Follows the instructions into the par. 2.5, 4.6.

8.4 Alarms

If an alarm message appears on the display of the machine, go to the paragraph 3.4 and follow the instructions about how to solve it.

9. ACCESSORIES

9.1 Working plane

The working plane is an accessory, which makes easier the pouches sliding during sealing operation.

APPLICATION OF WORKING PLANE TO THE SEALER

To applicate the working plane to the sealing machine, it is necessary to introduce the cavity (n.1-pict.9.1) on the backside of the plane into the two screws on the front cover n.5-pict.4.1 of the sealing machine

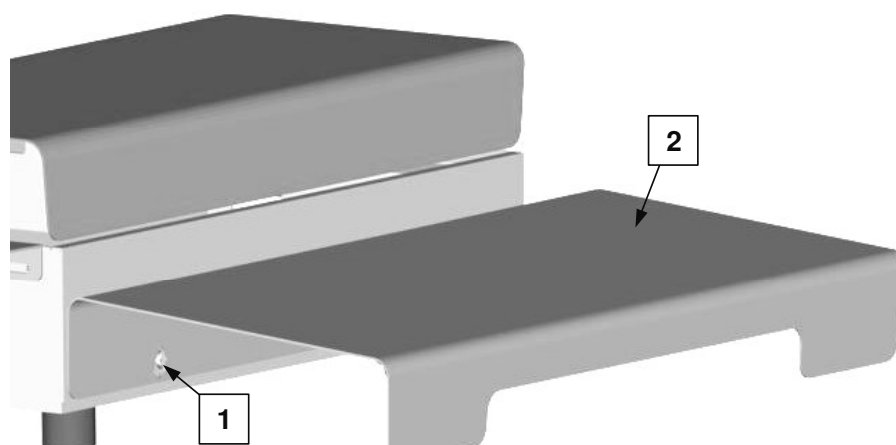

pict.9.1

Fabbricante / Manufacturer / Constructeur / Hersteller

Gandus Saldatrici s.r.l socio unico
Via Milano, 5 – 20010 CORNAREDO - ITALY
Tel +390293194.1 – Fax +390293568803
info@gandus.it – www.gandus.it