



GIMA

PROFESSIONAL MEDICAL PRODUCTS

Gima S.p.A.
Via Marconi, 1 - 20060 Gessate (MI) Italy
gima@gimaitaly.com - export@gimaitaly.com
www.gimaitaly.com

PODOSCOPIO - PODOSCOPE PODOSCOPE - PODOSCOPIO PODOSCÓPIO - PODOSKOP

Manuale d'uso
User Manual
Notice d'utilisation
Manual del usuario
Manual do utilizador
Gebrauchs- und instandhaltungsanleitung



ATTENZIONE: Gli operatori devono leggere e capire completamente questo manuale prima di utilizzare il prodotto.

ATTENTION: The operators must carefully read and completely understand the present manual before using the product.

AVIS: Les opérateurs doivent lire et bien comprendre ce manuel avant d'utiliser le produit.

ATENCIÓN: Los operadores tienen que leer y entender completamente este manual antes de utilizar el producto.

ATENÇÃO: Os operadores devem ler e entender completamente este manual antes de usar o produto.

ACHTUNG: Diese Anleitung muss vor dem Einsatz des Produkts aufmerksam gelesen und vollständig verstanden werden.

REF 27363



Gima S.p.A.
Via Marconi, 1
20060 Gessate (MI) Italy
Made in Italy



CE

CONTENTS

Chapter 1	GENERAL DESCRIPTION	15
1.1	General Identification data.....	15
1.2	General characteristics	16
1.3	Technical features and voltage	16
1.4	Classification and reference norms	17
1.5	Electrical features and voltage.....	18
1.6	Components identification.....	18
	Electrical schema	19
1.7	General safety warning	19
Chapter 2	INSTALLATION	20
2.1	Transport and stocking	20
2.2	Conditions for installation	20
2.3	Electric connection	23
Chapter 3	INSTRUCTIONS FOR USE.....	23
3.1	Use of the podoscope	23
Chapter 4	MAINTENANCE	23
4.1.	Ordinary maintenance.....	23

Chapter 1

GENERAL DESCRIPTION

1.1 General identification data

This instruction handbook is considered as an essential document of podoscope 27363. Therefore they must not be separated in case of cessation to third parties, in accordance with EC Directive 93/42/EC and following norms.

This handbook gives the operator all the relevant information to carry out the following operations correctly:

- INSTALLATION - USAGE - MAINTENANCE

Instructions for a correct installation are contained in the par.

2.2 CONDITIONS FOR THE INSTALLATION.



Follow the instructions for use



Read carefully this manual for the installation, the usage and the maintenance of the podoscope.

COMPANY NAME

Commercial Trademark: Gima

Typology: Podoscope









Model: 27363

Manufacturer: Gima S.p.A. - Via Marconi, 1 20060 Gessate (MI) - Italy

IDENTIFICATION AND LABELS, SYMBOLS EXPLICATION



Warning: maximum load 135 kg (297 lbs)

 Via Marconi, 1 - 20060 Gessate (MI) Italy		MADE IN ITALY			
PODOSCOPIO PODOSCOPE REF 27363			SERIAL NUMBER	 MM/YYYY	
MAINS VOLTAGE 220-240V	FREQUENCY 50/60 Hz	POWER 7,5 VA	 2 x T 0.5 A - 5x20 mm		

On each device you will find a similar plate with the manufacturer's identification



Protection against indirect contacts: device of Class II



Device with applied part Type B



Follow the instructions for use



Attention: danger

1.2 Description and general characteristics

The particular system of light diffusion of the Podoscope 27363 enables you to study the patient's foot plant and to mark the parts with the heaviest pressure.

Its structure is very simple: the methacrylate structure is an excellent light conductor and it is also endowed with an inner light source: in this way you can discover variations of colour intensity on the foot plant, corresponding to higher or lower plant pressure.
The base is of ABS.

A separable net cable with plug, a jack, and a led strip are its electric components.

1.3 Technical features and voltage

Material	Transparent methacrylate
Tension	220-240 V single-phase
Frequency	50/60 Hz
Power	7,5 A
Illumination	Led Strip light
Wavelength	520 nm
Risk Class EN 62471	Exempt
Nr. of included plugs	Nr. 1
2 Fuses:	5x20 mm: 2 x T 0,5 A – 250 V
Conditions of use	temperature: from 10°C up to 40°C umidity: from da 20% up to 85%
Stocking conditions:	temperature: from 0°C up to 60°C umidity: from da 10% up to 90%

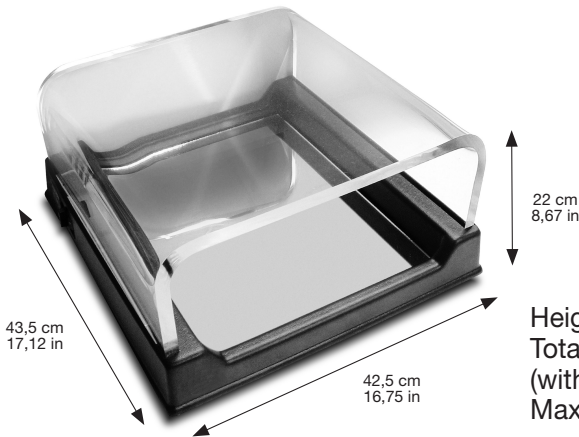

Height	22 cm (8.67 in)
Total weight (with package)	Kg 9,0 (19.84 lb)
Maximum load	Kg 135 (297 lb)

1.4 Classification and reference norms

The Podoscope 27363 allows to evaluate the foot print, supplying secondary indirect information on the heel alignment and on the toes situation. It allows to evaluate the signs and the symptoms of a particular condition of the foot, in order to formulate a judgement on the health conditons and establish a therapy or a chiropody treatment.

The device is designed and realized according to the law prescriptions concerning electromedical equipment, and it's therefore indicated for medical purposes and used in clinics, consultation rooms and sports centres by operators with knowledge of biomechanics, like doctors in sport medicine, orthopedic specialists and physiotherapists.

Reference harmonized norms:

- CEI EN 60601-1 "Safety of electromedical devices"
- CEI EN 60601-1-2 "Collateral harmonized norm for electromedical devices – Electromagnetic compatibility."

Classification according to safety norm EN 60601-1:

- Portable device
- Class II
- Type B
- Ordinary protection against humidity
- Do never use with inflammable anaesthetics
- Voltage: 220-240 V ~ 50/60 Hz.

The device highlights areas of the foot plant with heaviest pressure thanks to different intensity of light. In order to visualize them the patient just needs to step on the podoscope barefoot. The particular features of this device grant adequate protection and isolation against direct or indirect electric shocks

and against electric or mechanic surcharge.

The thermic power implied in this podoscope avoid dangerous overheating for materials and components.

Electric isolation and well-balanced distances between the surfaces avoid the formation of electric arches. In addition to this, the podoscope has a solid mechanical structure and an excellent stability on the ground.

It has no sharp edges, therefore there exists no danger of mechanical nature both for operators and patients.

Each part of the inner circuits are assembled and fixed in such a solid way so as to stand up to the often adverse transport conditions.

As to indirect shocks, the device is classified in Class II.

As to current leakage it can be classified in class B.

No essential performance is defined for this device.

1.5 Electrical features of the podoscope

The conventional led power supply functions with single-phase current (220-240 V - 50/60 Hz); the mark is ILC NanoLED.

The power cord - H05VV-F - 2 mt (6.56 ft) long, section 2 x 0.75 bears the mark IMQ, has a two-pole plug and it is connected to the podoscope through a connector.

The internal connectors of the power cord satisfy the norm CEI 20-20 (type H05V).

1.6 Components identification

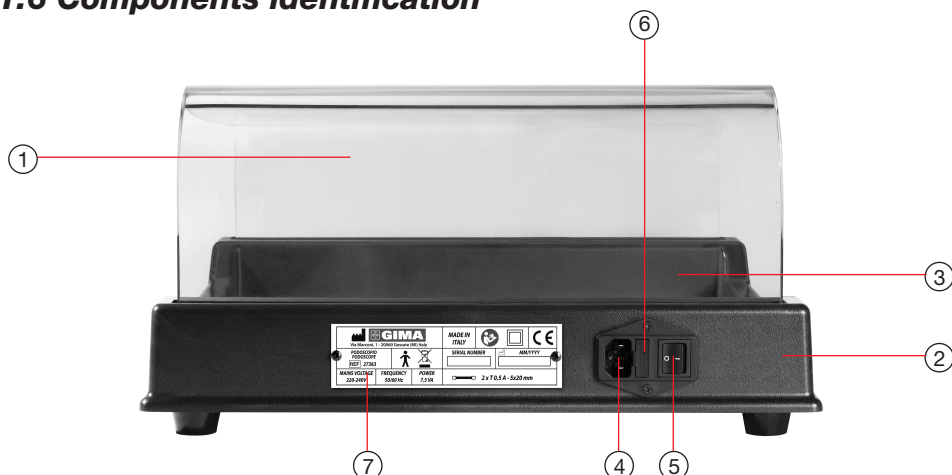

- 1 - Transparent methacrylate surface
- 2 - Basement in ABS (acrylonitrile butadiene styrene with wiring)
- 3 - Mirror
- 4 - Power cord jack
- 5 - On/Off switch
- 6 - Fuse holder
- 7 - Identification plate

Electric schema

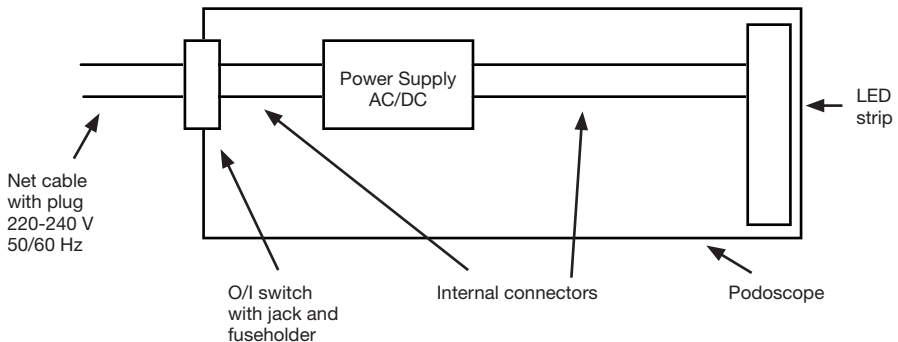

1.7 General safety warning

As far as safety is concerned, this podoscope has undergone all the necessary checks and inspections as foreseen.

In order to respect the safety prerequisites during the whole life of your device, we suggest that you always take the following precautions:

- A. Always unplug the podoscope during maintenance operations.
- B. Do not move the podoscope while using it.
- C. Each time before the usage, check the functioning of the cable and of its electric parts.
- D. Operators must not intervene or take any initiatives on the podoscope which are not foreseen in this handbook.



Attention: do not charge the podoscope with loads over 135 kg (297 lb) in order to avoid any risk of breaking



Attention: no change of the device is allowed



Attention: not complying with warnings will relieve GIMA company from any kind of responsibility.

Chapter 2

INSTALLATION

2.1 Transport and stocking

Before shipping the podoscope 27363 is covered by a film and packed in a cardboard with protective panels inside.

The box contains the assembled podoscope and its cable (which must be obviously connected to the apparatus before using it); the caoutchouc is not included.

In case of a longer storage, please store the whole package clean and dry.

2.2 Conditions for installation

1. Unpack the podoscope completely.
2. Disposal of packing elements (plastic foams, polystyrene, polyethylene, cardboard) must follow your local waste disposal guidelines.
3. Verify that the podoscope has not been damaged during transport. In case, please contact the manufacturer immediately.

IMPORTANT Please take notice of the fact that light stripes and/or microscopic luminescent dots on the transparent surface of the podoscope are due to the particular nature of its material and do not impair the equipment functionality.

RIGHT POSITIONING AND SAFETY INSTALLATION OF THE PODOSCOPE

Position the podoscope so as to leave enough room around it to be able to safely operate and to connect and disconnect easily the device to the power supply network.

We suggest to attach a handle on the wall as indicated in the scheme below to make easier for patients to go on and down the podoscope.

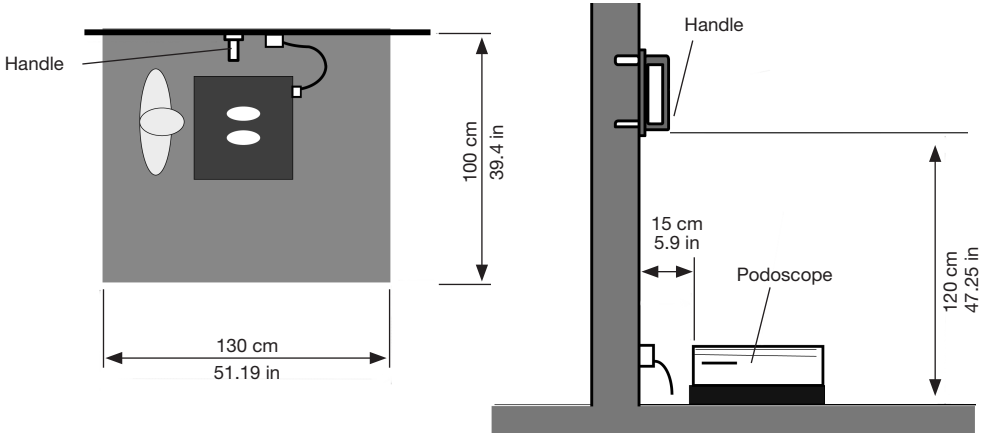

Electromagnetic compatibility (EMC)

The podoscope needs special precautions concerning electromagnetic compatibility (EMC) and must be installed and operated according to the EMC information contained in this manual.

In order to avoid possible risks of electromagnetic interferences, do not use radio frequency portable or mobile devices near the podoscope. Generally the podoscope should not be used near or together other equipments; in the case this would not be possible, it's necessary to observe its operativity to verify the normal functioning.

GUIDANCE AND MANUFACTURER'S DECLARATION – ELECTROMAGNETIC EMISSIONS

The equipment **27363** is intended for use in the electromagnetic environment specified below. The customer or the user of the equipment **27363** should assure that it is used in such an environment

Emissions test	Compliance	Electromagnetic environment – guidance
RF emissions CISPR 11	Group 1	The equipment 27363 must emit electromagnetic energy in order to perform its intended function. Nearby electronic equipment may be affected.
RF emissions CISPR 11	Class B	The 27363 is suitable for use in all establishments other than domestic and those directly connected to the public low-voltage power supply network that supplies buildings used for domestic purposes
Harmonic emissions IEC 61000-3-2	Compliant	
Voltage fluctuations/ flicker emissions IEC 61000-3-3	Compliant	

GUIDANCE AND MANUFACTURER'S DECLARATION – ELECTROMAGNETIC IMMUNITY			
<p>The equipment 27363 is intended for use in the electromagnetic environment specified below. The customer or the user of the equipment 27363 should assure that it is used in such an environment</p>			
Immunity test	IEC 60601 Test level	Compliance level	Electromagnetic environment guidance
Electrostatic discharge (ESD) IEC 61000-4-2	±2 KV contact ±4 KV contact ±6 KV contact ±2 KV air ±4 KV air ±8 KV air	±2 KV contact ±4 KV contact ±6 KV contact ±2 KV air ±4 KV air ±8 KV air	Floor should be wood, concrete or ceramic tile. If floors are covered with synthetic material, the relative humidity should be at less 30%
Electrical fast transient/burst IEC 61000-4-5	±2 KV for power supply lines	±2 KV for power supply lines	Mains power quality should be that of a typical commercial or hospital environment
Surge IEC 61000-4-5	±1 KV differential mode ±2 KV common mode	±1 KV differential mode ±2 KV common mode	Mains power quality should be that of a typical commercial or hospital environment
Voltage dips, short interruptions and voltage variations on power supply input lines IEC 61000-4-11	<5% U_T (>95% dip in U_T) for 0,5 cycle 40% U_T (60% dip in U_T) for cycle 70% U_T (30% dip in U_T) for cycle <5% U_T (>95% dip in U_T) for 5 s	<5% U_T (>95% dip in U_T) for 0,5 cycle 40% U_T (60% dip in U_T) for cycle 70% U_T (30% dip in U_T) for cycle <5% U_T (>95% dip in U_T) for 5 s	Mains power quality should be that of a typical commercial or hospital environment. If the user of 27363 requires continued operation during power mains interruptions, it is recommended that the 27363 be powered from an uninterruptible power supply or a battery.
Power frequency (50/60 HZ) magnetic field IEC 61000-4-8	3A/m	3A/m	Power frequency magnetic field should be at levels characteristic of a typical location in a typical commercial or hospital environment.

2.3 Electric connection

Connect your podoscope verifying that the indications on the plate correspond to the local electric voltage, then plug it into the socket which must be supplied with a surcharge safety device.

The use of accessories, transducers and cables, except the ones sold by the producer as spare parts, can increase the emissions and decrease the EM (electromagnetic) device immunity.

Chapter 3

INSTRUCTIONS FOR USE

3.1 Use of the podoscope

Plug the podoscope in to light it up, then switch on (5) to position I.

Let the patient step on the transparent basis of the podoscope and make sure that the feet are right in the centre of it. Then proceed with a sight examination on the mirror.

If have not been supplied caoutchouc the examination can be performed only if the patient is barefoot, otherwise lay the caoutchouc on the transparent surface. This material is also useful to check the validity of arch support treatments.



Warning: don't let step on patients with injured foot skin

At the end of the examination, press (5) again to put it back to the 0 position and turn it off.



IMPORTANT: please help elderly patients step on the podoscope and remain steady

Chapter 4

MAINTENANCE

4.1 Ordinary maintenance

The ordinary maintenance described in this paragraph can be carried out directly by the operator.

1. Disinfect the surface of the podoscope after each use with disinfectants indicated for this material: **never use alcohol nor solvents for this purpose.**
2. Clean the podoscope at least once a week, always after having unplugged it. Use clean clothes, slightly moistened with water and detergent for glasses. **Never use alcohol nor solvents for this purpose.**

3. The frequency of the checks on internal wiring may vary according to external conditions (i.e. presence of dust) and repeated usage.
4. As a general rule, we recommend a sight inspection every six months or at least within one year after the purchase of the podoscope, to ascertain whether there is no wear and tear in the cable or in the electric connections.

If you have to replace one of the fuses, open the fuse holder placed in the position indicated in the picture on page 19.

Then get out the blown fuse with a suitable instrument and replace it with a T 0,5 A – 5x20 250V fuse.

If you have to replace the power cord, the new one must have the same characteristics and certification of the original one.

In the case of troubles or needs to replace spare parts, always contact the producer.



WARNING: all maintenance should be done only after disconnecting the device from the electrical mains.

LED REPLACEMENT

In case of troubles with LED, please contact the Technical Assistance Service. Do not make direct operations, as Warranty shall become void.



WARNING: all the operations to replace led should be made only by the authorized technical assistance.



Disposal: *The product must not be disposed of along with other domestic waste. The users must dispose of this equipment by bringing it to a specific recycling point for electric and electronic equipment. For further information on recycling points contact the local authorities, the local recycling center or the shop where the product was purchased. If the equipment is not disposed of correctly, fines or penalties may be applied in accordance with the national legislation and regulations.*

GIMA WARRANTY CONDITIONS

Congratulations for purchasing a GIMA product. This product meets high qualitative standards both as regards the material and the production. The warranty is valid for 12 months from the date of supply of GIMA. During the period of validity of the warranty, GIMA will repair and/or replace free of charge all the defected parts due to production reasons. Labor costs and personnel traveling expenses and packaging not included. All components subject to wear are not included in the warranty. The repair or replacement performed during the warranty period shall not extend the warranty. The warranty is void in the following cases: repairs performed by unauthorized personnel or with non-original spare parts, defects caused by negligence or incorrect use. GIMA cannot be held responsible for malfunctioning on electronic devices or software due to outside agents such as: voltage changes, electro-magnetic fields, radio interferences, etc. The warranty is void if the above regulations are not observed and if the serial code (if available) has been removed, cancelled or changed. The defected products must be returned only to the dealer the product was purchased from. Products sent to GIMA will be rejected.

