

Light efficiency:



Light quality:



Color temperature:



Output: 11822 lm

Peak: 4158 cd

Power: 151 W

PF: 0,98

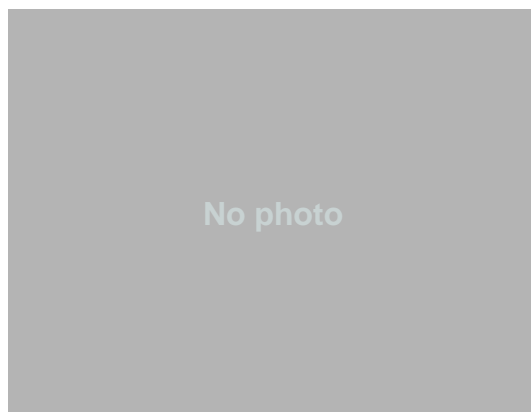

Product name:

D-tec Original 090518

Item number:

Original

Date and time:

09-05-2018 09:49:55

Description:

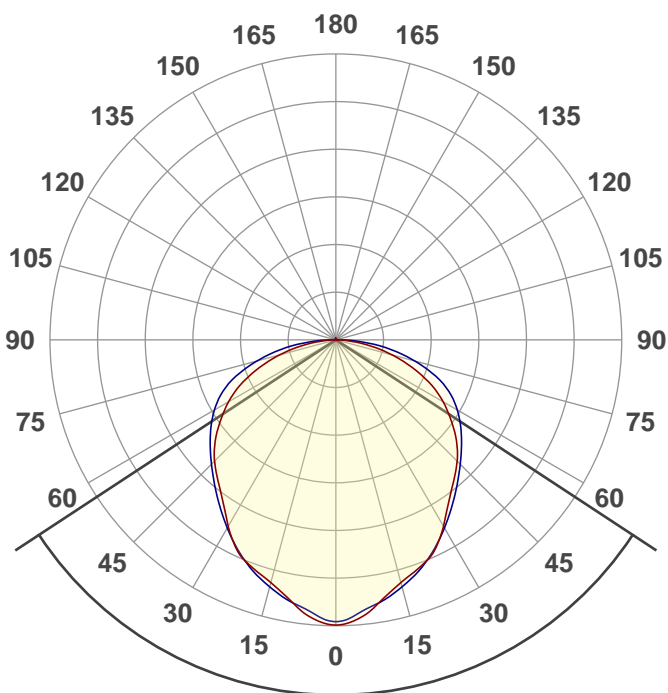

Beam angle

113,4°



CIE 1931
x: 0,326
y: 0,336

Spectra

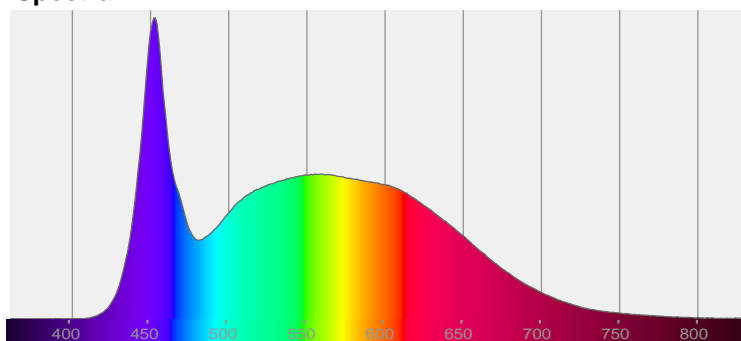

Power

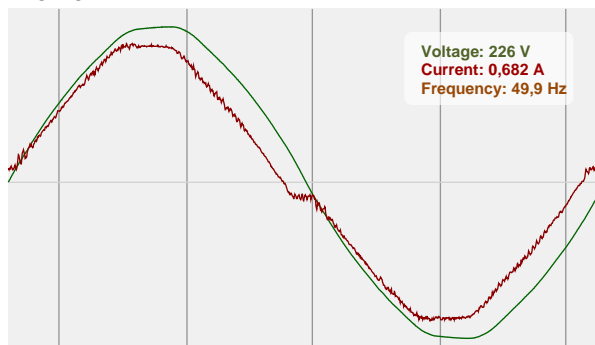

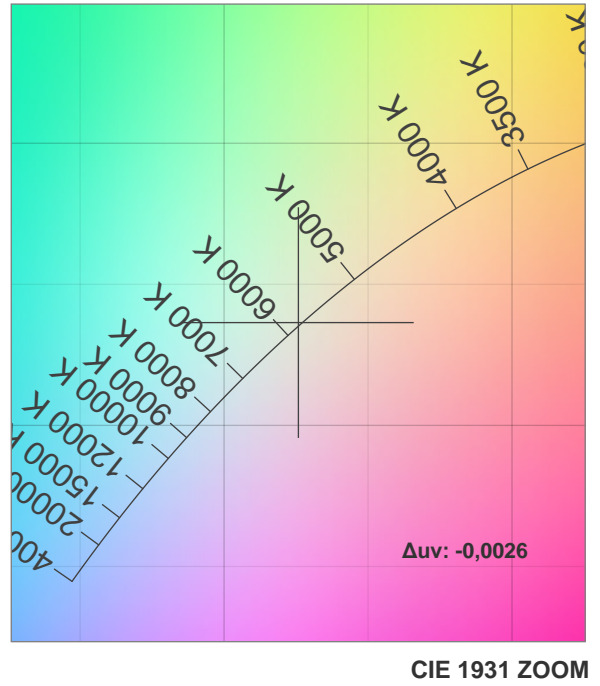
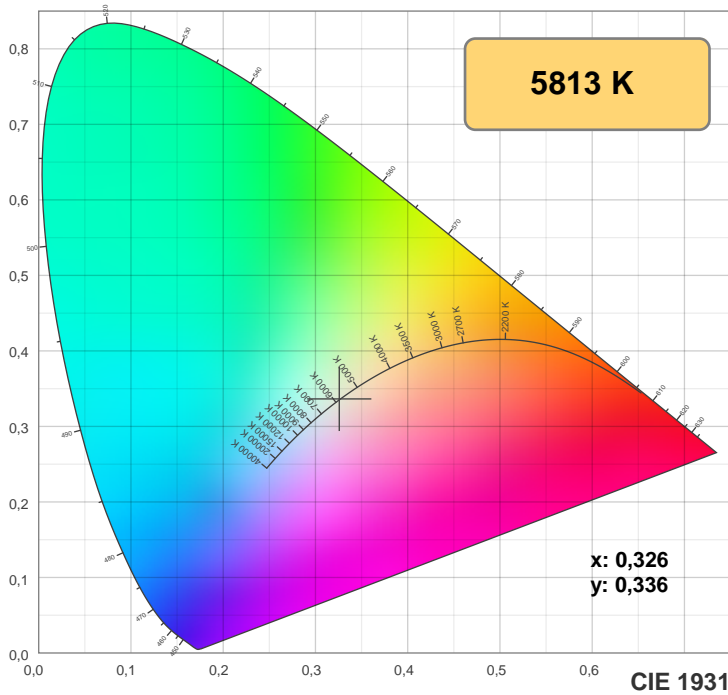

TM30: 85,6

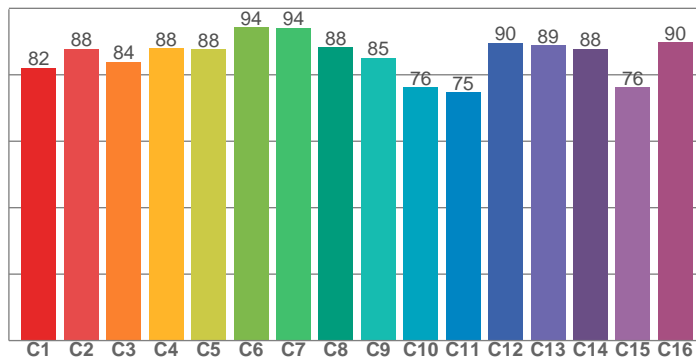

CRI: 89,0 (R1-R8)

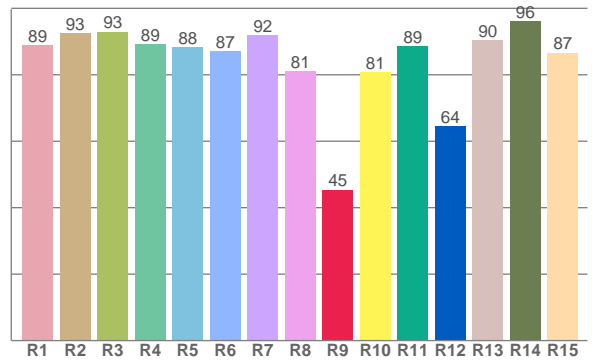

CQS: 85,8

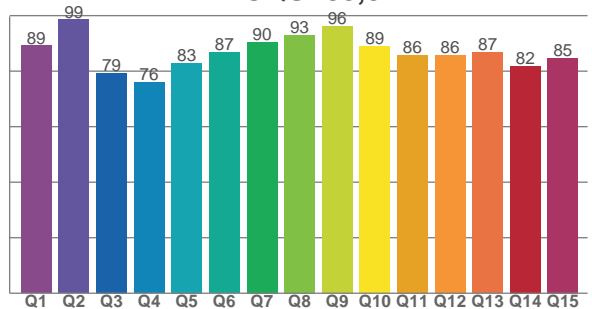

CRI R values, only R1-R8 are used to calculate final CRI value

R1	R2	R3	R4	R5	R6	R7	R8	R9	R10	R11	R12	R13	R14	R15
88,9	92,6	92,9	89,1	88,3	87,2	91,9	81,1	45,4	80,7	88,7	64,5	90,4	96,2	86,6

TM30 C values, 16 binned values out of total of 99 C values

C1	C2	C3	C4	C5	C6	C7	C8	C9	C10	C11	C12	C13	C14	C15	C16
82,0	87,7	84,0	88,0	87,7	94,3	94,1	88,2	85,1	76,2	74,7	89,7	88,9	87,8	76,3	89,7

CQS Q values

Q1	Q2	Q3	Q4	Q5	Q6	Q7	Q8	Q9	Q10	Q11	Q12	Q13	Q14	Q15
89,2	98,6	79,4	76,0	82,9	86,8	90,5	93,0	96,3	88,9	85,7	85,8	86,8	81,9	84,8

Color parameters

Color temperature	Color rendering index	Red component	Color fidelity	Color gamut	Color quality scale	Color coordinate cie 1931	Color coordinate cie 1931	Color coordinate	Color coordinate	Color deviation from black body
CCT	CRI	CRI R9	TM30 Rf	TM30 Rg	CQS	x	y	u	v	Δuv
5813 K	89,0	45,4	85,6	97,6	85,8	0,326	0,336	0,204	0,316	-0,0026

Rf 85,6
Fidelity index Rf

Rg 97,6
Gammut index Rg

Hue Bin	R _f	Graphic shifts (%)	
		Chroma	Hue
1	82	-8%	0%
2	88	-5%	4%
3	84	-3%	7%
4	88	-1%	5%
5	88	-1%	3%
6	94	0%	-1%
7	94	-2%	-1%
8	88	-6%	2%
9	85	-7%	10%
10	76	-3%	13%
11	75	3%	14%
12	90	4%	4%
13	89	7%	-2%
14	88	3%	-5%
15	76	7%	-18%
16	90	-4%	-4%

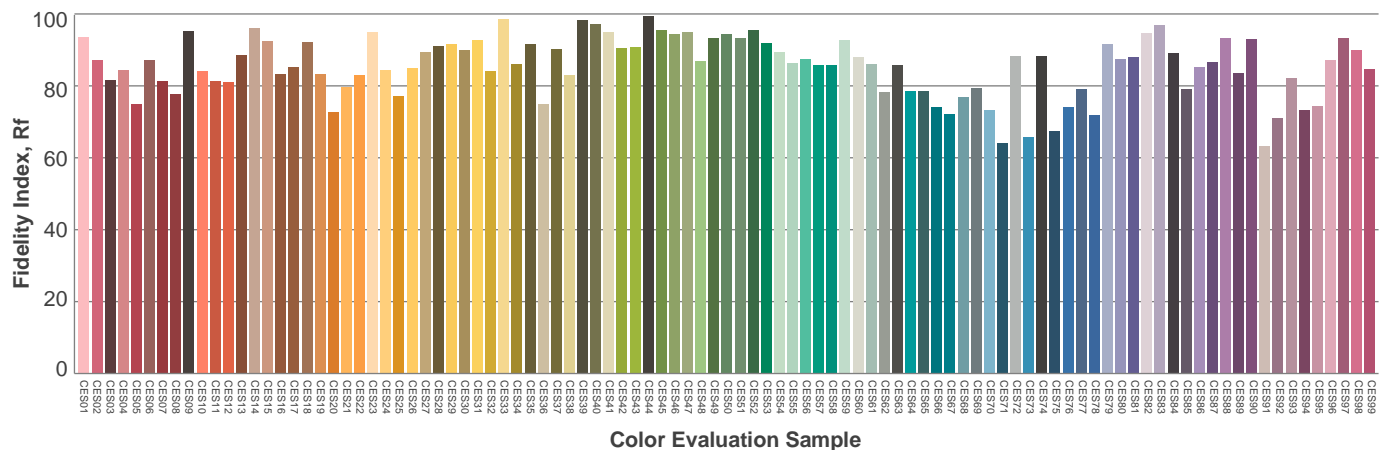
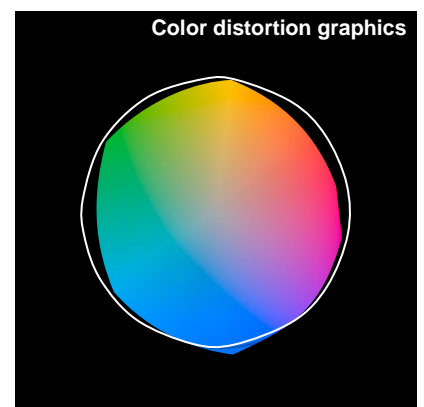
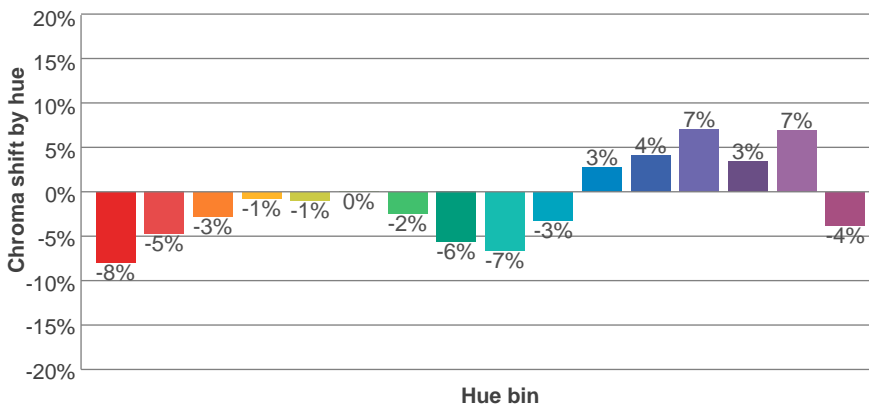
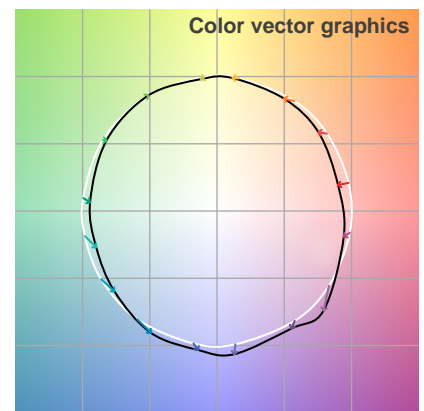
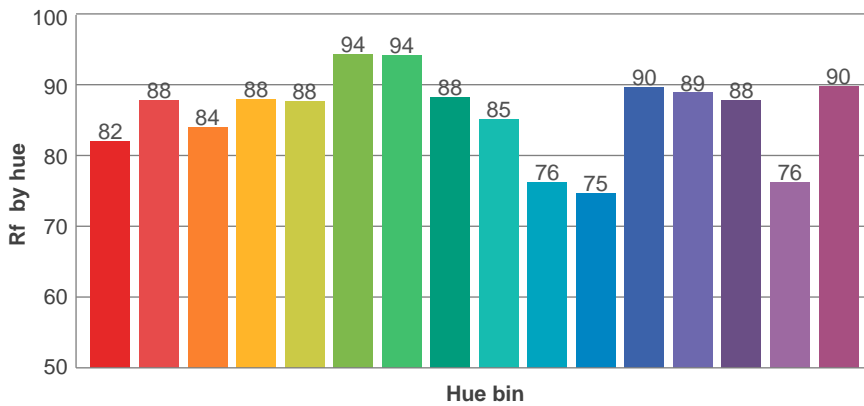
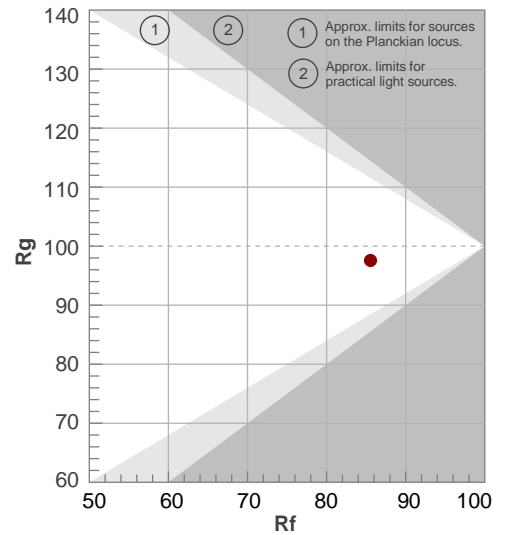

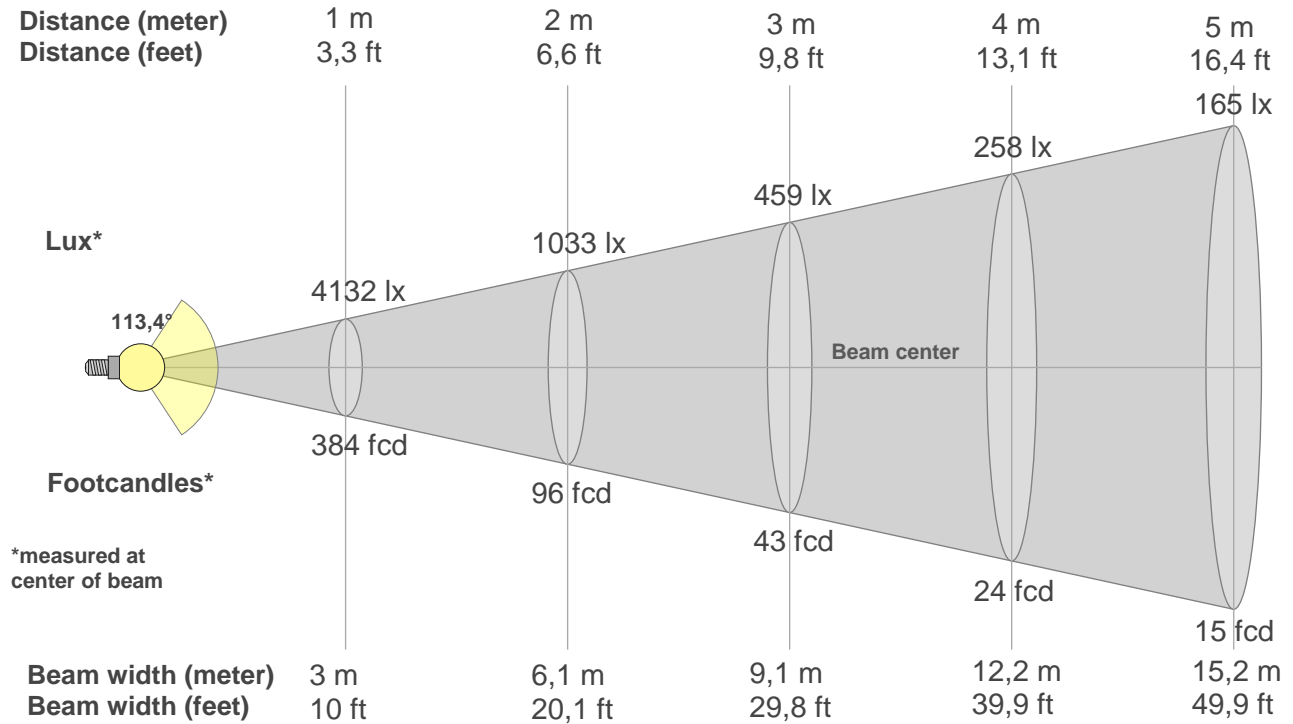

Beam intensities from 1-20m

1m	2m	3m	4m	5m	6m	7m	8m	9m	10m	11m	12m	13m	14m	15m	16m	17m	18m	19m	20m
3,3ft	6,6ft	9,8ft	13,1ft	16,4ft	19,7ft	23ft	26,2ft	29,5ft	32,8ft	36,1ft	39,4ft	42,7ft	45,9ft	49,2ft	52,5ft	55,8ft	59,1ft	62,3ft	65,6ft
4132lx	1033lx	459lx	258lx	165lx	115lx	84lx	65lx	51lx	41lx	34lx	29lx	24lx	21lx	18lx	16lx	14lx	13lx	11lx	10lx
383,9fc	96fcd	42,7fcd	24fcd	15,4fcd	10,7fcd	7,8fcd	6fcd	4,7fcd	3,8fcd	3,2fcd	2,7fcd	2,3fcd	2fcd	1,7fcd	1,5fcd	1,3fcd	1,2fcd	1,1fcd	1fcd

Intensities in 0° c-plane

0°	5°	10°	15°	20°	25°	30°	35°	40°	45°	50°	55°	60°	65°	70°	75°	80°	85°	90°	95°
4132	4074	3868	3679	3552	3403	3150	2890	2687	2508	2302	2061	1813	1529	1195	855	523	225	45	5
100%	99%	94%	89%	86%	82%	76%	70%	65%	61%	56%	50%	44%	37%	29%	21%	13%	5%	1%	0%

Intensities in 90° c-plane

0°	5°	10°	15°	20°	25°	30°	35°	40°	45°	50°	55°	60°	65°	70°	75°	80°	85°	90°	95°
4132	4007	3883	3742	3584	3390	3179	2966	2763	2576	2401	2232	2052	1837	1552	1195	822	435	120	14
100%	97%	94%	91%	87%	82%	77%	72%	67%	62%	58%	54%	50%	44%	38%	29%	20%	11%	3%	0%

Intensities in 180° c-plane

0°	5°	10°	15°	20°	25°	30°	35°	40°	45°	50°	55°	60°	65°	70°	75°	80°	85°	90°	95°
4132	4074	3868	3679	3552	3403	3150	2890	2687	2508	2302	2061	1813	1529	1195	855	523	225	45	5
100%	99%	94%	89%	86%	82%	76%	70%	65%	61%	56%	50%	44%	37%	29%	21%	13%	5%	1%	0%

Intensities in 270° c-plane

0°	5°	10°	15°	20°	25°	30°	35°	40°	45°	50°	55°	60°	65°	70°	75°	80°	85°	90°	95°
4132	4007	3883	3742	3584	3390	3179	2966	2763	2576	2401	2232	2052	1837	1552	1195	822	435	120	14
100%	97%	94%	91%	87%	82%	77%	72%	67%	62%	58%	54%	50%	44%	38%	29%	20%	11%	3%	0%

Beam angle 50%	Field angle 10%	Cutoff angle 2,5%	Intensity ratio in 120° cone	Intensity ratio in 90° cone
113,4°	166,9°	178,5°	73,8%	49,3%

ISO candela diagram

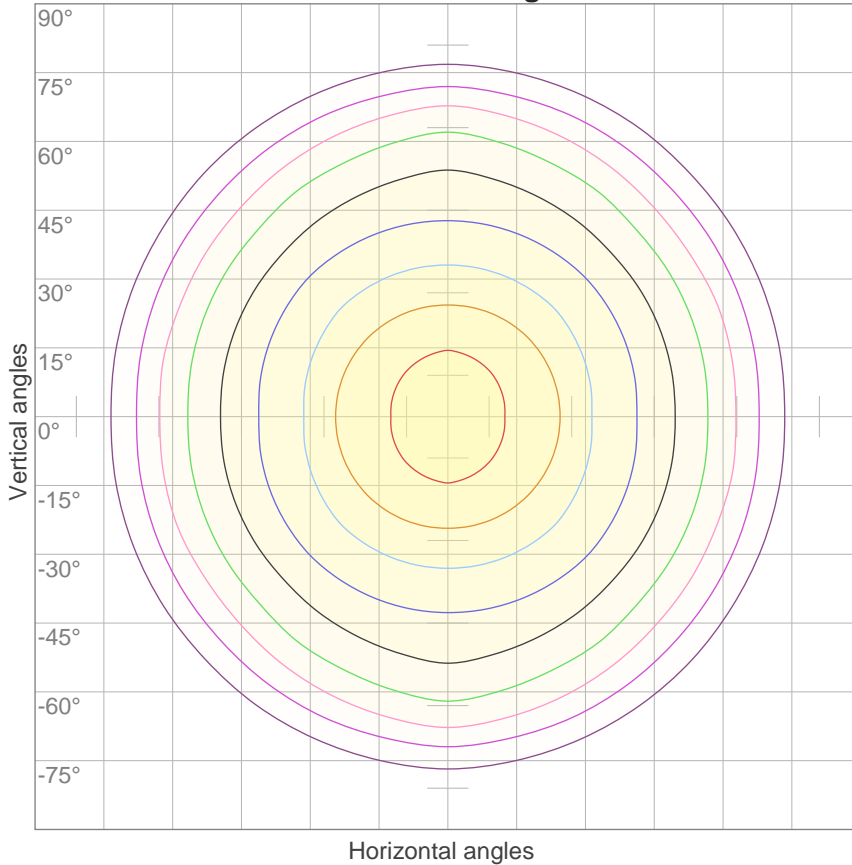

10%	413 cd
20%	826 cd
30%	1240 cd
40%	1653 cd
50%	2066 cd
60%	2479 cd
70%	2893 cd
80%	3306 cd
90%	3719 cd

Conditions:

Number of c-planes: 8

Candela at center: 4132 cd

ISO lux diagram

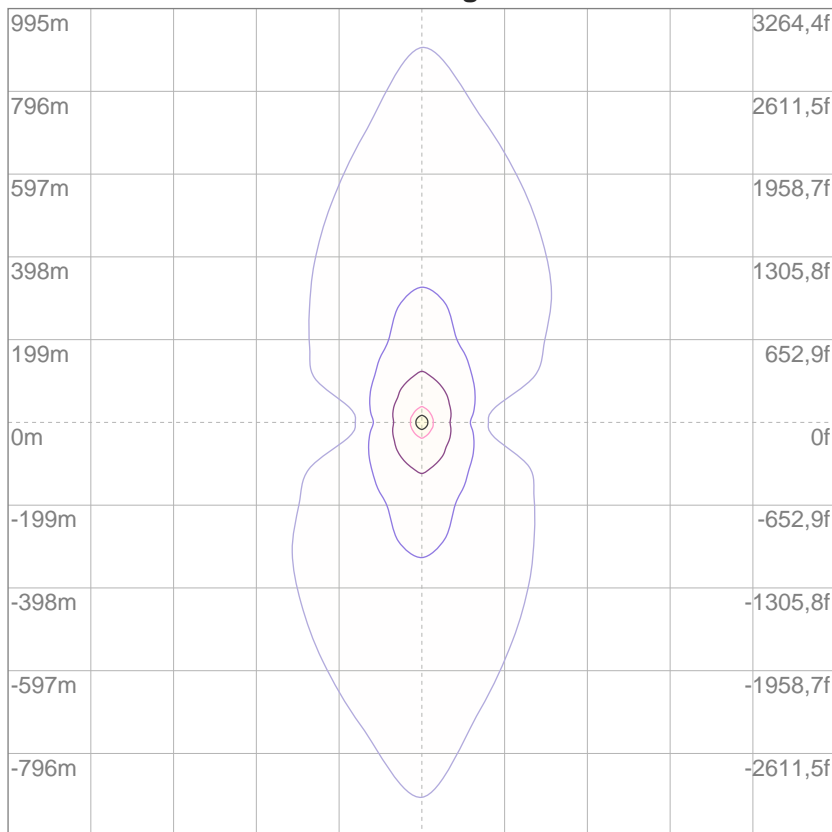

3%	1,24 lx
5%	2,07 lx
10%	4,13 lx
30%	12,4 lx
50%	20,7 lx

Conditions:

Number of c-planes: 8

Lux at center: 41,3 lx

Lux distribution on a surface when lamp is mounted at 10 meters from the surface.

Mounting height: 10 meters (33 feet)

Glare Evaluation According to UGR

p Ceiling		70	70	50	50	30	70	70	50	50	30
p Walls		50	30	50	30	30	50	30	50	30	30
p Floor		20	20	20	20	20	20	20	20	20	20
Room size X Y		Viewing direction at right angles to lamp axis					Viewing direction parallel to lamp axis				
2H	2H	21,0	22,3	21,3	22,6	22,8	21,4	22,8	21,7	23,0	23,3
	3H	22,8	24,0	23,1	24,3	24,6	23,6	24,8	23,9	25,1	25,4
	4H	23,5	24,7	23,9	25,0	25,3	24,5	25,7	24,9	26,0	26,3
	6H	24,0	25,2	24,4	25,5	25,8	25,4	26,5	25,7	26,8	27,1
	8H	24,2	25,3	24,6	25,6	26,0	25,7	26,8	26,1	27,1	27,4
	12H	24,3	25,4	24,7	25,7	26,1	25,9	27,0	26,3	27,3	27,7
4H	2H	21,8	23,0	22,2	23,3	23,6	22,1	23,3	22,5	23,6	23,9
	3H	23,8	24,8	24,2	25,2	25,5	24,5	25,5	24,9	25,8	26,2
	4H	24,7	25,6	25,1	26,0	26,3	25,6	26,5	26,0	26,9	27,2
	6H	25,4	26,2	25,8	26,6	27,0	26,6	27,4	27,0	27,7	28,2
	8H	25,6	26,3	26,0	26,8	27,2	27,0	27,7	27,4	28,1	28,5
	12H	25,8	26,4	26,2	26,9	27,3	27,3	28,0	27,7	28,4	28,8
8H	4H	25,1	25,9	25,6	26,3	26,7	25,9	26,7	26,4	27,1	27,5
	6H	26,0	26,6	26,5	27,0	27,5	27,1	27,7	27,5	28,1	28,6
	8H	26,3	26,9	26,8	27,3	27,8	27,6	28,1	28,1	28,6	29,1
	12H	26,6	27,0	27,1	27,5	28,0	28,0	28,5	28,5	29,0	29,5
12H	4H	25,2	25,9	25,7	26,3	26,8	26,0	26,6	26,4	27,0	27,5
	6H	26,1	26,7	26,6	27,1	27,6	27,1	27,7	27,6	28,1	28,6
	8H	26,5	27,0	27,0	27,5	28,0	27,7	28,2	28,2	28,6	29,1
Variation of the observer position for the luminaire distance S											
S = 1,0H		+0,1 / -0,1					+0,1 / -0,1				
S = 1,5H		+0,2 / -0,3					+0,2 / -0,2				
S = 2,0H		+0,3 / -0,5					+0,2 / -0,4				
Standard table		BK07					BK08				
Correction summand		9,4					10,9				
Corrected glare indices referring to 11822 lm total luminous flux											

Coefficients of Utilization

Ceiling reflectance	80				70				50			30			10			0
	70	50	30	10	70	50	30	10	50	30	10	50	30	10	50	30	10	0
Wall reflectance	70	50	30	10	70	50	30	10	50	30	10	50	30	10	50	30	10	0
Floor reflectance	20	20	20	20	20	20	20	20	20	20	20	20	20	20	20	20	20	0
RCR	(RCR: Room Cavity Ratio)																	
	Room Values are expressed as percentage of Lumens delivered to the task surface																	
0	119	119	119	119	116	116	116	116	111	111	111	106	106	106	102	102	102	100
1	108	102	98	94	105	100	96	92	96	92	89	92	89	86	88	86	83	81
2	97	88	81	75	95	86	80	74	83	77	72	79	75	70	76	72	69	67
3	88	77	69	62	86	76	68	61	72	66	60	70	64	59	67	62	58	55
4	81	68	59	52	78	67	58	51	64	57	51	62	55	50	59	54	49	47
5	74	61	51	44	72	59	51	44	57	49	44	55	48	43	53	47	42	40
6	68	54	45	39	66	53	45	38	52	44	38	50	43	38	48	42	37	35
7	63	49	40	34	61	48	40	34	47	39	34	45	38	33	44	38	33	31
8	59	45	36	30	57	44	36	30	43	35	30	42	35	30	40	34	29	28
9	55	41	33	27	54	41	33	27	39	32	27	38	32	27	37	31	27	25
10	52	38	30	25	50	38	30	25	37	29	24	36	29	24	35	29	24	22

LAMPS (number of lamps)

Luminaire budgetary diagram

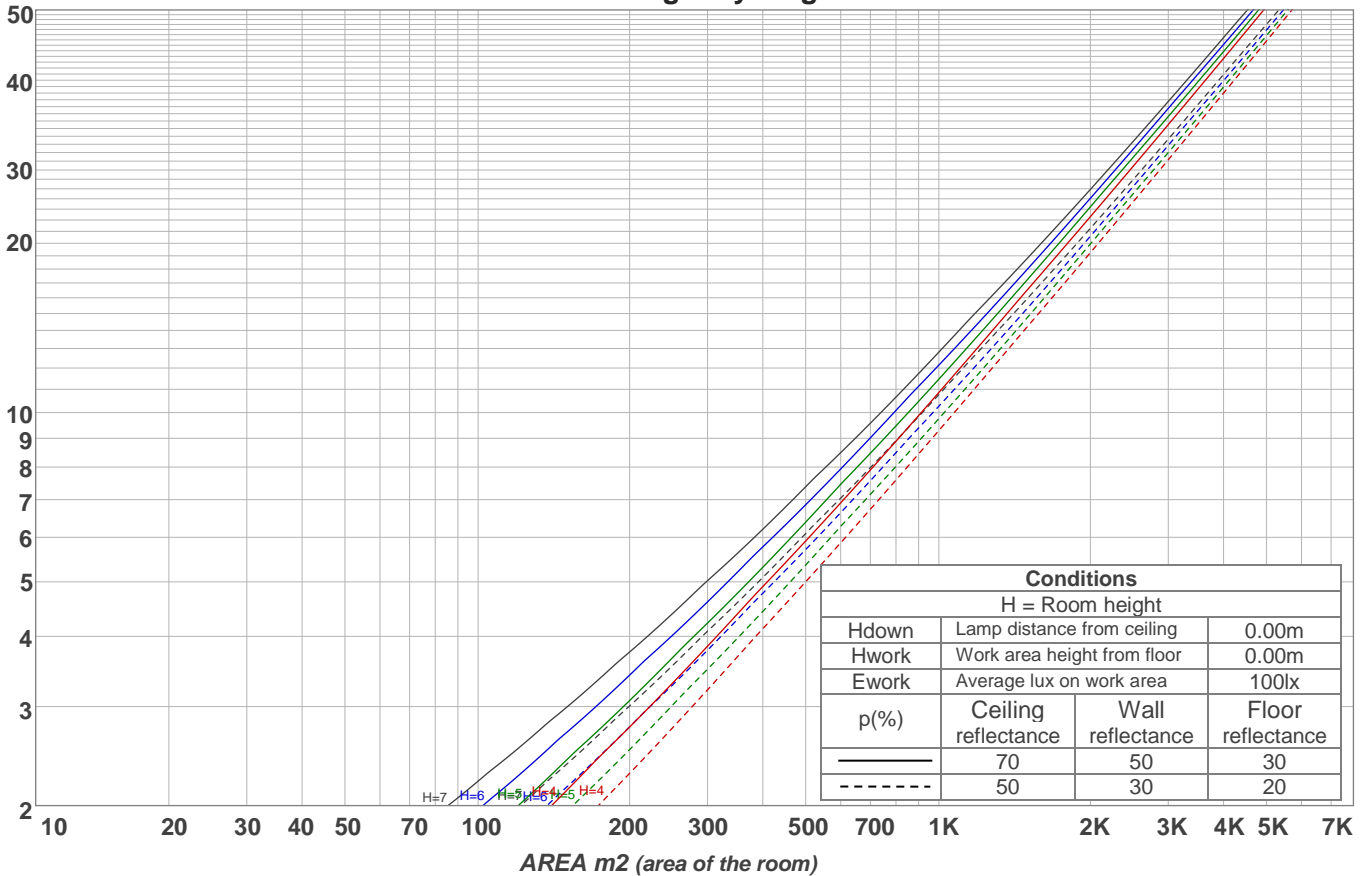

Zonal Lumen Summary

0°-10°	10°-20°	20°-30°	30°-40°	40°-50°	50°-60°	60°-70°	70°-80°	80°-90°
379 lm	1048 lm	1563 lm	1852 lm	1971 lm	1906 lm	1627 lm	1068 lm	353 lm
90°-100°	100°-110°	110°-120°	120°-130°	130°-140°	140°-150°	150°-160°	160°-170°	170°-180°
18,0 lm	5,65 lm	5,93 lm	6,08 lm	5,79 lm	5,18 lm	3,99 lm	2,59 lm	0,886 lm

Warmup curve

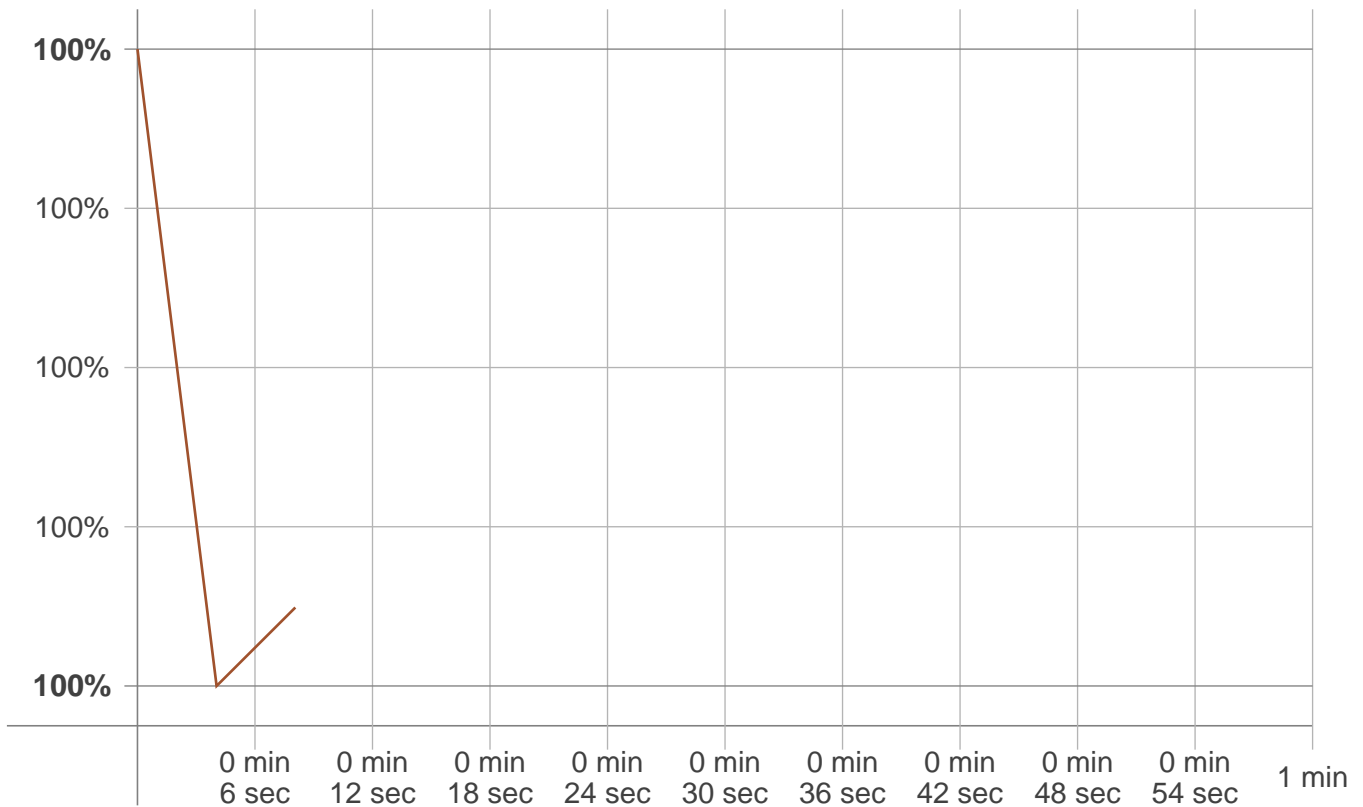

Warmup result

Warmup time:	Not completed
Warmup variation	0,0%

Warmup conditions

Stable period:	15 min
Stable change max:	2,0%
Minimum time:	15 min

Color temperature change

CCT start	CCT change	CCT end
5811 K	+2 K	5813 K

Output change

Output start	Output change	Output end
11827 lm	-4 lm	11822 lm

Flicker curve (complete sampled flicker signal)



Flicker frame (frame of one flicker period)

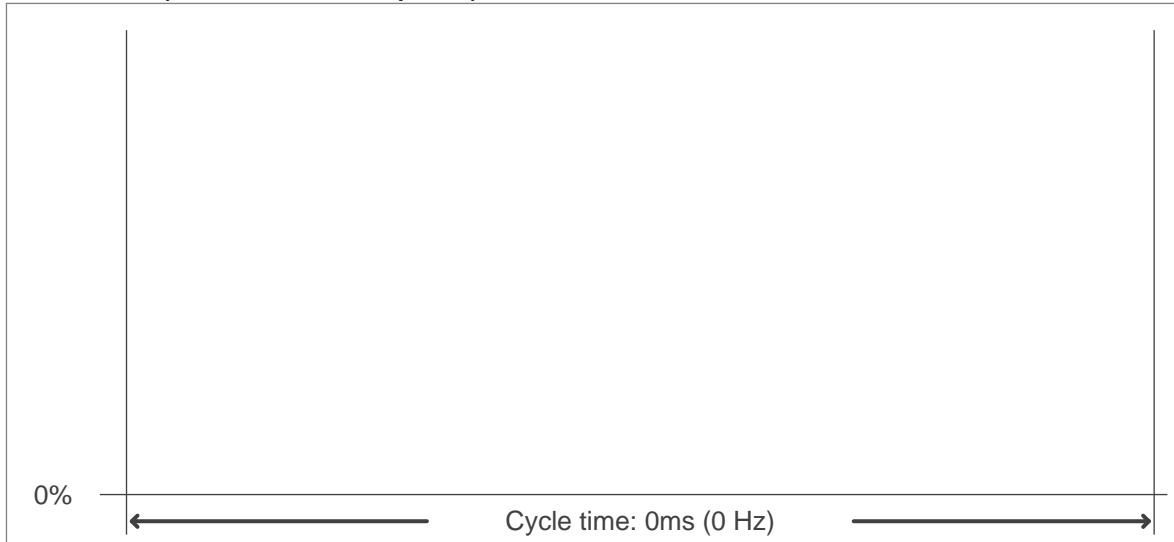

Flicker FFT (frequency scope of flicker curve)

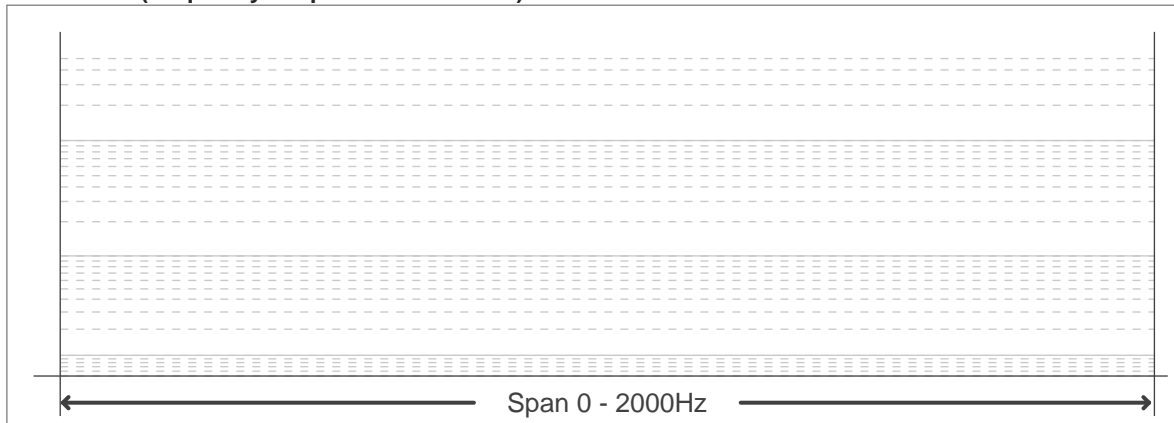

Flicker results:

Flicker frequency:	n/a Hz
Flicker index:	n/a
Flicker percentage:	n/a %
SVM: (Visual flicker)	n/a

Flicker conditions:

Sample rate:	60.000 samples/second
---------------------	------------------------------