

# Flow technical specification



**.mdd**

**.mdd has a leading position among manufacturers of office furniture with many awards that prove quality and continuously increase demand for it's products.**

The realities of today`s market require constant quality improvement at all levels of modern organization. This applies in particular to customer service, marketing, quality of products and also to quality of processes within the company.

Partnership relations among employees and with business partners form a base of economic growth and success of the company.

Constant investments in innovative machinery park, optimization of management systems and an expansion of production halls allow to minimize the lead times for the product of the highest quality.

**More than twenty years of experience in office furniture industry come with reference from a long list of companies and institutions to show their appreciation for an efficient and comprehensive service.**

**.mdd is highly aware of the environment.**

Being located in the forest region with lake by its side, .mdd takes the nature seriously and invests constantly in a modern and energy-efficient solutions to preserve the local life. Company puts emphasis on waste segregation and recycling. .mdd has been awarded for the exceptional care and involvement in waste disposal. All materials used are environmentally friendly and enjoy a high 95 % rate of being recycled.



## General informations:

### Warranty:

.mdd products – **5 years**.

Electrical components and fabric – **2 years**.

### Certificate - MFC:



### Assembly:

product delivered in separate elements

### Packing:

cardboard, bubble wrap, stretch foil

### Compliant with standards:

DIN EN 13849-1:2007, Performance Level B;

RoSH 2011/65/UE;

LVD; EU Directive 2006/95/EC;

EMC according to EU Directive 2004/108/EC;

PN-EN 55014-1:2017-06;

PN-EN 55014-2:2015-06;

PN-EN 60204-1:2010P;

PN-EN 61000-1-2:2016-11;

PN-EN 61000-6-3:2008/A1:2012;

PN-EN 60335-1:2012;

PN-EN-ISO-12100\_2012P

### Boards density:

12 mm – 690 – 750 kg/m<sup>3</sup>

18 mm – 650 – 690 kg/m<sup>3</sup>

28 mm – 610 – 630 kg/m<sup>3</sup>

36 mm – 610 – 630 kg/m<sup>3</sup>

Flow

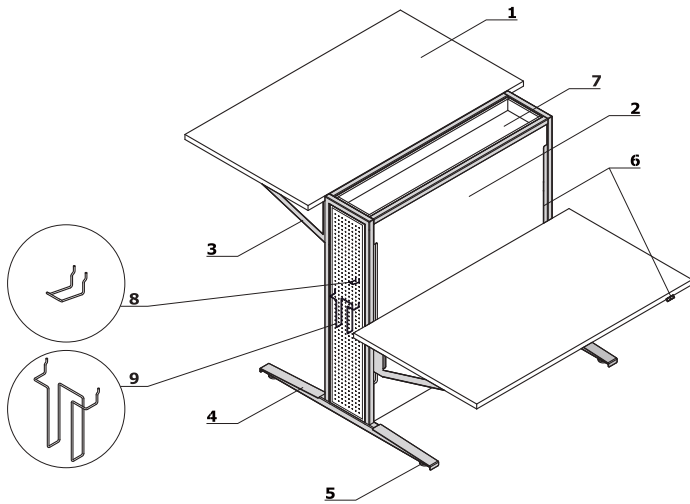

- 1. **Worktop** - MFC 28 mm, ABS edge, max load 50 kg
- 2. **Body:**
  - **frame** - powder coated metal
  - **filling** - 12mm melamine plate
  - fixed body dimensions for all the worktop sizes
- 3. **Frame** - powder coated metal
- 4. **Foot** - powder coated metal
- 5. **Leveling** - 5 mm range
- 6. **Electrical height adjustment** - 650 - 1300 mm range:
  - A - basic control panell; the sensitivity of the anti-collision system is set to Medium
  - B - OPTION WITH EXTRA CHARGE - up and down keypad with memory; the ability to change the sensitivity of the anti-collision system within 3 levels: Low, Medium, High
  - C - Bluetooth module:
    - \* compatible with both panel A and B
    - \* the ability to change the sensitivity of the anti - collision system within 3 levels: Low, Medium, High
    - \* control via MDD Desk BT application (downloadable from Google Play or App Store). The app has a time interval function that informs the user about the need of changing body position (from sitting to standing or standing to sitting)
    - \* both worktops are operated by one motor, thus only one worktop can be adjusted at a time
- 7. **Shelf**
- 8. **Hanger** - chrome wire
- 9. **A5 documents bracket** - chrome wire

A

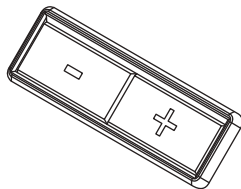

B

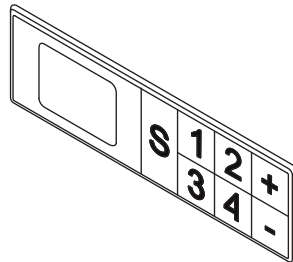

C

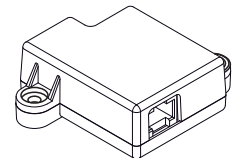

Frame technical specification

- **Height adjustment** - 40 mm/sec
- **Drive** - 1 motor with drive distribution
- **Noise level** - < 48dB
- **Power supply** - 230V, 256W
- **EU Directives** - 206/95EC, UI508 1999, UL 1004 R7 06, WE DC 2004/108WE
- **Stand** - by mode 0.1W
- **Anti colision mechanism**

Flow	Date of preparation 02.08.2021	The data contained in this document is valid in the day of its preparation. Change of the product, as long as it does not affect the basic features of it, does not require consistent updates of the document.	page 3/5 technical description
------	-----------------------------------	---	-----------------------------------

**Bench desks with electric height adjustment - sit-stand \***

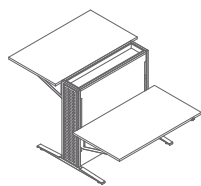

**FLW14**  
1400 / 1900 / 1300  
103.76 kg

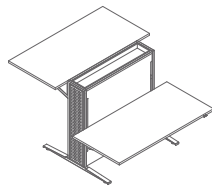

**FLW16**  
1600 / 1900 / 1300  
114.4 kg

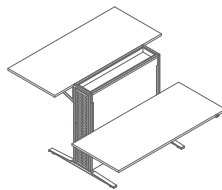

**FLW18**  
1800 / 1900 / 1300  
117.5 kg

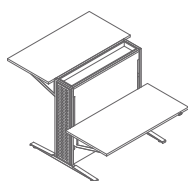

**FLW24**  
1400 / 1700 / 1300  
101 kg

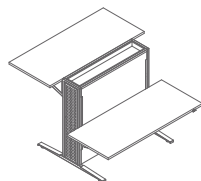

**FLW24**  
1600 / 1700 / 1300  
105 kg

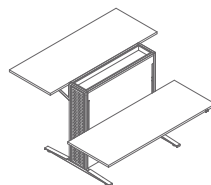

**FLW28**  
1800 / 1700 / 1300  
111 kg

**Accessories \***

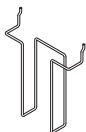

**FLW1Z**  
170 / 45 / 225  
0.2 kg



**FLW2Z**  
60 / 37 / 28  
0.05 kg

\* dimensions expressed in millimeters: width x depth x height

<b>Flow</b>	Date of preparation 02.08.2021	The data contained in this document is valid in the day of its preparation. Change of the product, as long as it does not affect the basic features of it, does not require consistent updates of the document.	page 4/5
			<b>products</b>

Top



Body

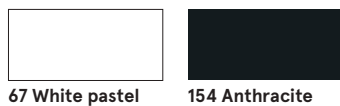

Frame - metal

